

NPD12-9Ah 12V9Ah

Specifications

Nominal Voltage		12V
Rated capacity (20 hour rate)		9Ah
Dimensions	Length	151±1.5mm(5.94inch)
	Width	65±1mm(2.56inch)
	Height	94±1mm(3.70inch)
	Total Height	100±1mm(3.94inch)
Approx. Weight		2.6kg(5.7lbs)±4%



Outer dimensions (mm)

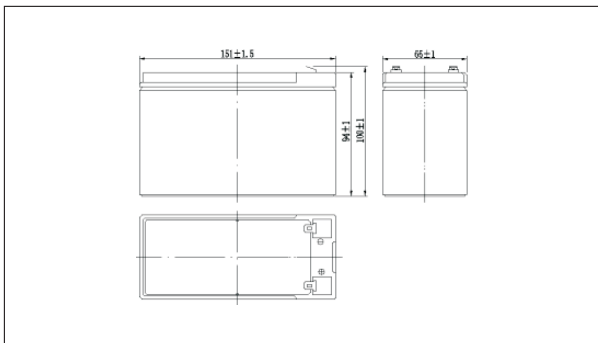

Terminal Type (mm)

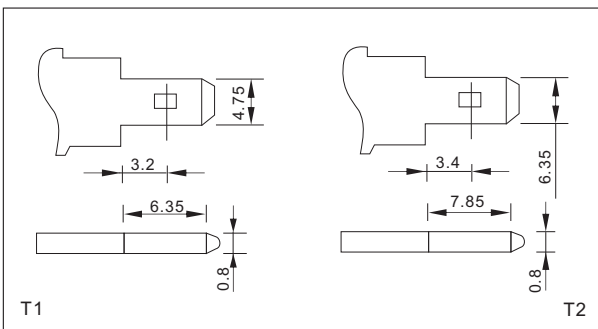

Characteristics

Capacity (25°C)	20HR(10.5V)	9Ah
	10HR(10.5V)	8.5Ah
	1HR(9.60V)	5.9Ah
Terminal type		T1/T2
Internal resistance (Fully charged, 25°C)		Approx. 19m Ω
Capacity affected by temperature (20HR)	40°C	102%
	25°C	100%
	0°C	85%
	-15°C	65%
Self-discharge (25°C)	3 months	Remaining Capacity:91%
	6 months	Remaining Capacity:82%
	12 months	Remaining Capacity:65%
Nominal operating temperature		25°C ±3°C(77°F ±5°F)
Operating temperature range	Discharge	-15°C~50°C(5°F~122°F)
	Charge	-10°C~50°C(14°F~122°F)
	Storage	-20°C~50°C(-4°F~122°F)
Float charging voltage(25°C)		13.50 to 13.80V Temperature compensation: -18mV/°C
Cyclic charging voltage(25°C)		14.50 to 15.00V Temperature compensation: -30mV/°C
Maximum charging current		2.7A
Maximum discharge current		135A(5 sec.)
Designed floating life(20°C)		5 years

Construction

Component	Positive plate	Negative plate	Container	Cover	Separator	Electrolyte	Safety valve	Terminal
Raw material	Lead dioxide	Lead	ABS	ABS	AGM	Sulfuric acid	Rubber	Copper

Constant Current Discharge Characteristics Unit:A(25°C,77°F)

F.V/Time	5min	10min	15min	30min	60min	2h	3h	4h	5h	10h	20h
9.60V	34.9	22.0	17.3	9.64	5.91	3.22	2.30	1.85	1.57	0.86	0.47
9.90V	33.8	21.4	16.9	9.44	5.82	3.21	2.28	1.83	1.56	0.85	0.46
10.2V	32.4	20.5	16.2	9.15	5.67	3.18	2.27	1.82	1.55	0.84	0.45
10.5V	31.0	19.6	15.7	8.93	5.56	3.13	2.25	1.81	1.54	0.84	0.45
10.8V	29.3	18.5	14.9	8.60	5.39	3.05	2.18	1.75	1.49	0.82	0.44

Constant Power Discharge Characteristics Unit:W(25°C,77°F)

F.V/Time	5min	10min	15min	30min	60min	2h	3h	4h	5h	10h	20h
9.60V	389	249	197	110	69.2	37.7	27.3	21.9	18.7	10.3	5.49
9.90V	378	241	192	108	67.2	37.5	27.1	21.7	18.6	10.2	5.47
10.2V	362	231	185	104	65.5	37.2	26.9	21.6	18.5	10.1	5.45
10.5V	346	221	179	102	64.2	36.6	26.7	21.4	18.4	10.1	5.42
10.8V	327	209	169	98.1	62.3	35.7	25.9	20.8	17.8	9.87	5.37

Note: The above characteristics data can be obtained within three charge or discharge cycles.

NPD12-9Ah 12V9Ah

● **Discharge characteristics(25°C)**

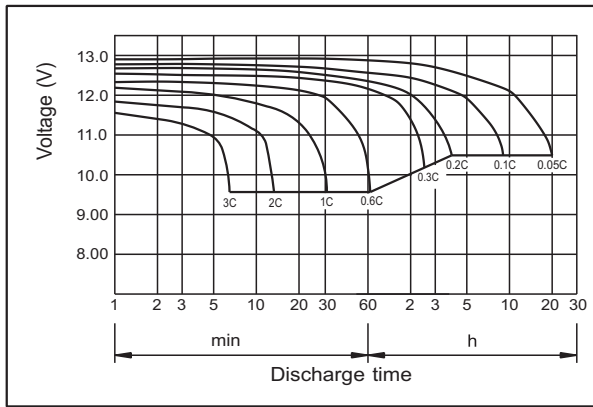

● **Charging characteristics (25°C)**

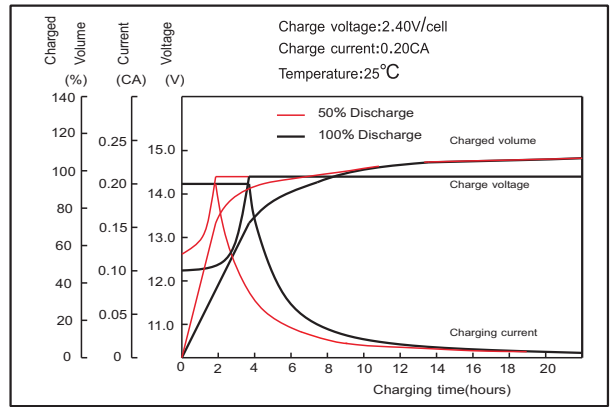

● **Temperature effects on Capacity**

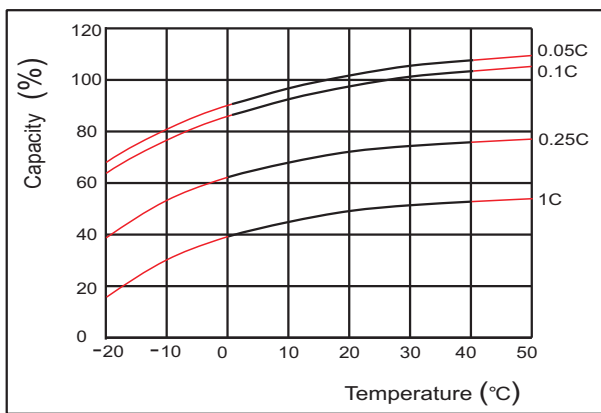

● **Self-discharge characteristics**

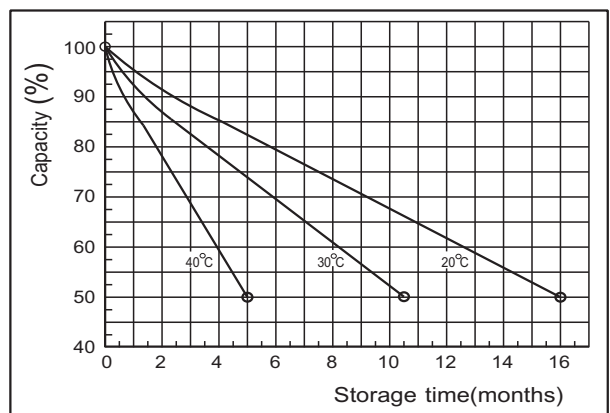

● **Floating life on Temperature**

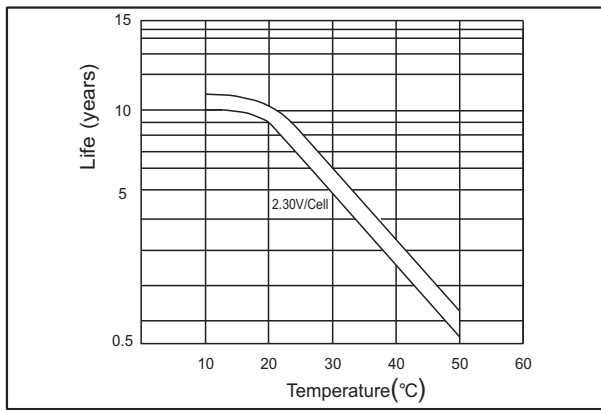

● **Cycle life on D.O.D (25°C)**

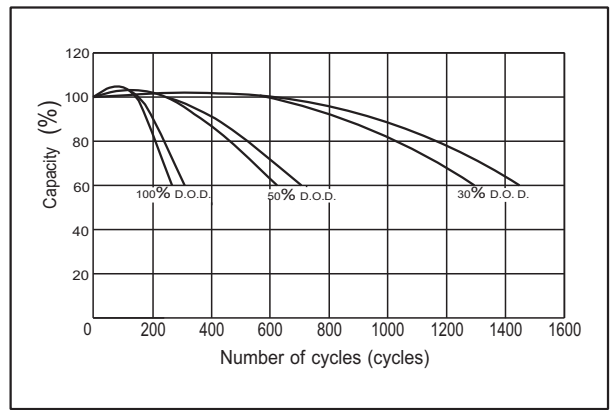

● **The relationship for OCV and Capacity (25°C)**

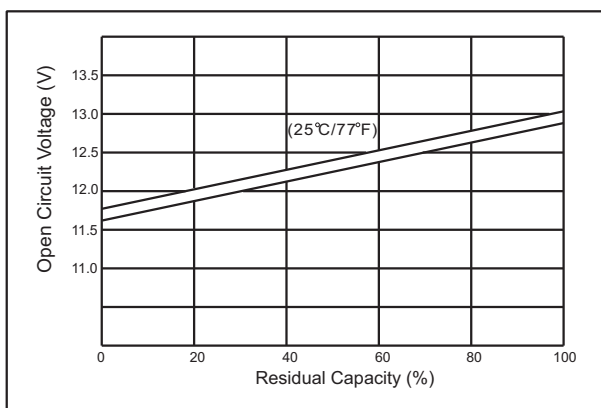

● **The relationship for Charging voltage and Temperature**

