

NP6-1.2Ah 6V1.2Ah



● **Specifications**

Nominal Voltage		6V
Rated capacity (20 hour rate)		1.2Ah
Dimensions	Length	98±1mm(3.86inch)
	Width	25±1mm(0.98inch)
	Height	52±1mm(2.05inch)
	Total Height	58±1mm(2.28inch)
Approx. Weight		0.28kg(0.62lbs)±5%

● **Outer dimensions (mm)**

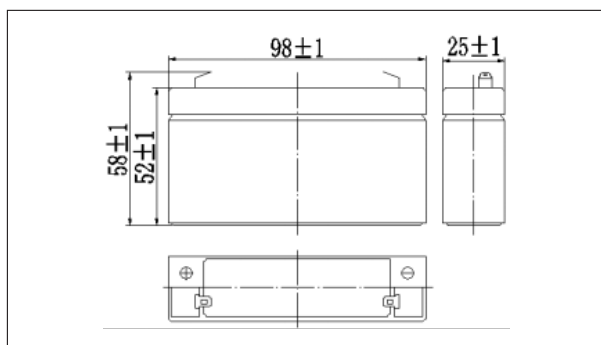

● **Terminal Type (mm)**

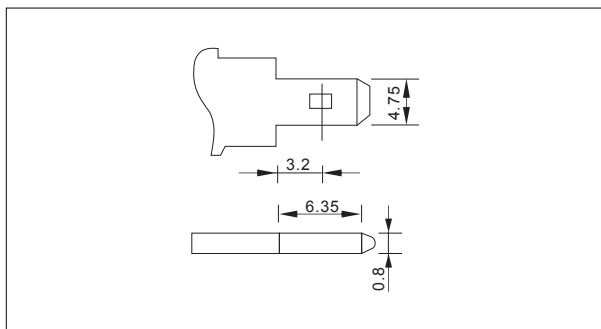

● **Characteristics**

Capacity (25°C)	20HR(3.50V)	1.2Ah
	10HR(3.50V)	1.1Ah
	1HR(3.20V)	0.72Ah
Terminal type		T1
Internal resistance (Fully charged,25°C)		Approx.52m Ω
Capacity affected by temperature (20HR)	40°C	102%
	25°C	100%
	0°C	85%
	-15°C	65%
Self-discharge (25°C)	3month	Remaining Capacity:91%
	6month	Remaining Capacity:82%
	12month	Remaining Capacity:65%
Nominal operating temperature		25°C ±3°C(77°F ±5°F)
Operating temperature range	Discharge	-15°C~50°C(5°F~122°F)
	Charge	-10°C~50°C(14°F~122°F)
	Storage	-20°C~50°C(-4°F~122°F)
Float charging voltage(25°C)		6.75 to 6.90V Temperature compensation: -9mV/°C
Cyclic charging voltage(25°C)		7.25 to 7.50V Temperature compensation: -15mV/°C
Maximum charging current		0.36A
Maximum discharge current		18A(5 sec.)
Designed floating life(20°C)		5 years

● **Construction**

Component	Positive plate	Negative plate	Container	Cover	Separator	Electrolyte	Safety valve	Terminal
Raw material	Lead dioxide	Lead	ABS	ABS	AGM	Sulfuric acid	Rubber	Copper

● **Constant Current Discharge Characteristics Unit:A(25°C,77°F)**

F.V/Time	5min	10min	15min	30min	60min	2h	3h	4h	5h	10h	20h
4.80V	4.58	2.90	2.27	1.28	0.79	0.43	0.30	0.25	0.21	0.11	0.06
4.95V	4.45	2.82	2.21	1.25	0.77	0.43	0.30	0.24	0.21	0.11	0.06
5.10V	4.26	2.70	2.13	1.21	0.75	0.42	0.29	0.24	0.21	0.11	0.06
5.25V	4.08	2.58	2.06	1.18	0.74	0.42	0.29	0.24	0.21	0.11	0.06
5.40V	3.85	2.44	1.95	1.14	0.72	0.41	0.28	0.23	0.20	0.11	0.06

● **Constant Power Discharge Characteristics Unit:W(25°C,77°F)**

F.V/Time	5min	10min	15min	30min	60min	2h	3h	4h	5h	10h	20h
4.80V	25.6	16.4	12.9	7.32	4.55	2.52	1.77	1.47	1.25	0.68	0.37
4.95V	24.8	15.9	12.6	7.18	4.48	2.50	1.76	1.46	1.24	0.68	0.36
5.10V	23.8	15.2	12.2	6.96	4.37	2.48	1.74	1.45	1.23	0.68	0.36
5.25V	22.8	14.6	11.7	6.79	4.28	2.44	1.73	1.44	1.23	0.67	0.36
5.40V	21.5	13.8	11.1	6.54	4.15	2.38	1.68	1.39	1.19	0.66	0.35

Note: The above characteristics data can be obtained within three charge or discharge cycles.

NP6-1.2Ah 6V1.2Ah

● Discharge characteristics(25°C)

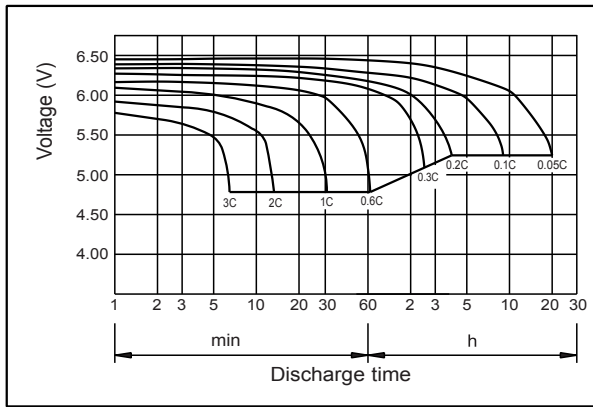

● Charging characteristics (25°C)

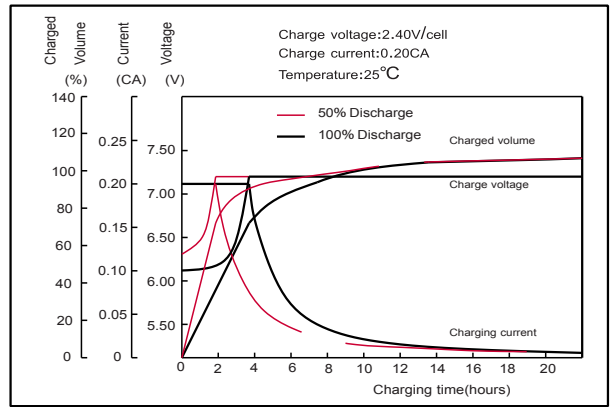

● Effect of temperature on capacity

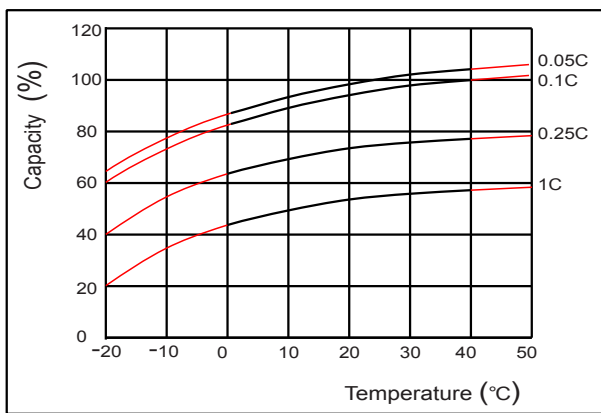

● Self-discharge characteristics

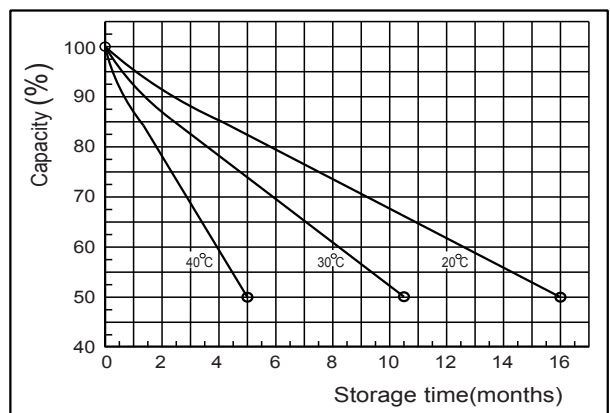

● Floating life on temperature

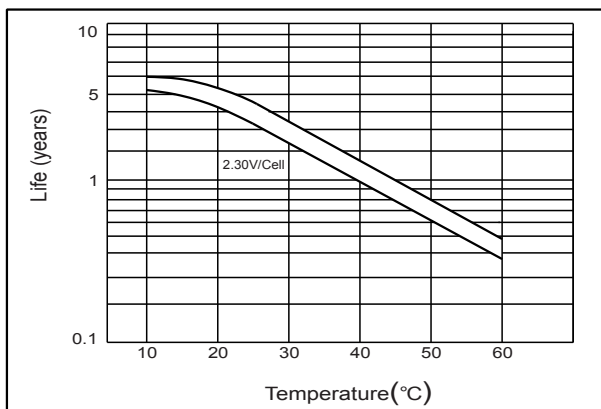

● Cycle life on D.O.D.(25°C)

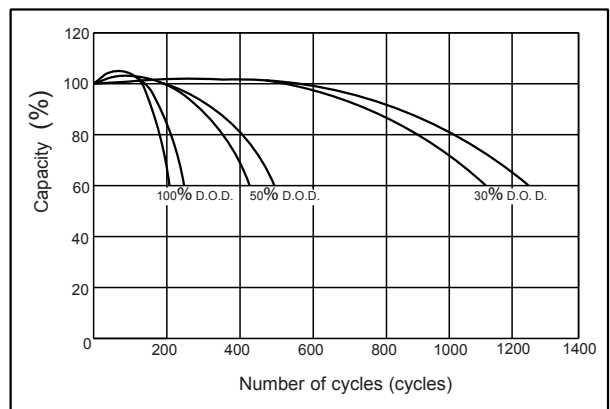

● The relationship for OCV and Capacity (25°C)

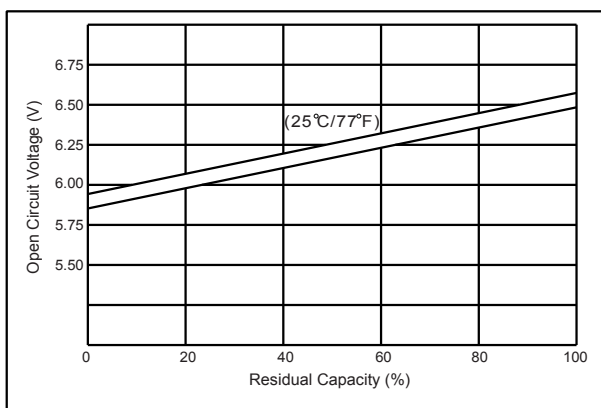

● The relationship for Charging voltage and Temperature

