

NP12-10Ah 12V10Ah

Specifications

Nominal Voltage	12V	
Rated capacity (20 hour rate)	10Ah	
Dimensions	Length	151±1.5mm(5.94inch)
	Width	98±1mm(3.86inch)
	Height	95±1mm(3.74inch)
	Total Height	101±1mm(3.98inch)
Approx. Weight	3.1kg(6.83lbs)±4%	



Outer dimensions (mm)

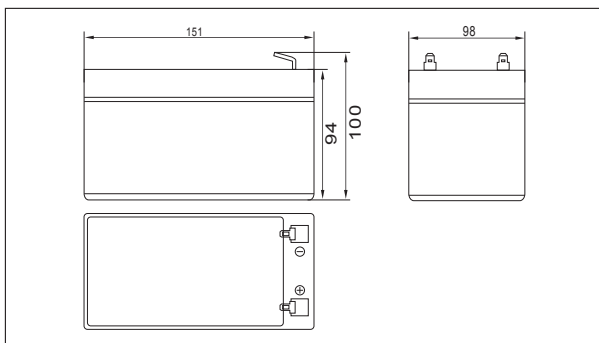

Terminal Type (mm)

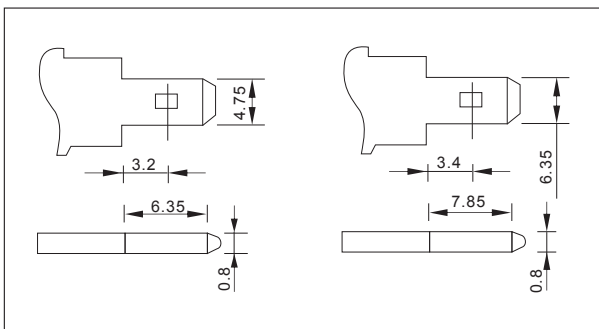

Construction

Component	Positive plate	Negative plate	Container	Cover	Separator	Electrolyte	Safety valve	Terminal
Raw material	Lead dioxide	Lead	ABS	ABS	AGM	Sulfuric acid	Rubber	Copper

Constant Current Discharge Characteristics Unit:A(25°C,77°F)

F.V/Time	5min	10min	15min	30min	60min	2h	3h	4h	5h	10h	20h
9.60V	38.2	24.2	18.9	10.7	6.55	3.6	2.48	2.05	1.74	0.95	0.51
9.90V	37.1	23.5	18.4	10.4	6.45	3.56	2.46	2.04	1.73	0.94	0.51
10.2V	35.5	22.5	17.8	10.1	6.29	3.53	2.45	2.02	1.72	0.94	0.50
10.5V	34.0	21.5	17.2	9.87	6.16	3.48	2.43	2.01	1.71	0.93	0.50
10.8V	32.1	20.3	16.3	9.51	5.97	3.39	2.36	1.95	1.66	0.91	0.49

Constant Power Discharge Characteristics Unit:W(25°C,77°F)

F.V/Time	5min	10min	15min	30min	60min	2h	3h	4h	5h	10h	20h
9.60V	426	273	215	122	75.8	41.9	29.4	24.4	20.8	11.4	6.09
9.90V	414	265	210	120	74.7	41.7	29.3	24.3	20.7	11.3	6.07
10.2V	396	254	203	116	72.8	41.3	29.1	24.1	20.6	11.3	6.04
10.5V	379	243	196	113	71.4	40.7	28.9	23.9	20.4	11.2	6.00
10.8V	358	229	185	109	69.2	39.6	28.0	23.2	19.8	11.0	5.88

Note: The above characteristics data can be obtained within three charge or discharge cycles.

Characteristics

Capacity (25°C)	20HR(10.5V)	10Ah
	10HR(10.5V)	9.3Ah
	1HR(9.60V)	6Ah
Terminal type		T2/T1
Internal resistance (Fully charged,25°C)		Approx.22m Ω
Capacity affected by temperature (20HR)	40°C	102%
	25°C	100%
	0°C	85%
	-15°C	65%
Self-discharge (25°C)	3month	Remaining Capacity:91%
	6month	Remaining Capacity:82%
	12month	Remaining Capacity:65%
Nominal operating temperature		25°C ±3°C(77°F ±5°F)
Operating temperature range	Discharge	-15°C~50°C(5°F~122°F)
	Charge	-10°C~50°C(14°F~122°F)
	Storage	-20°C~50°C(-4°F~122°F)
Float charging voltage(25°C)		13.50 to 13.80V Temperature compensation: -18mV/°C
Cyclic charging voltage(25°C)		14.50 to 15.00V Temperature compensation: -30mV/°C
Maximum charging current		3A
Maximum discharge current		150A(5 sec.)
Designed floating life(20°C)		5 years

NP12-10Ah 12V10Ah

● Discharge characteristics(25°C)



● Charging characteristics (25°C)

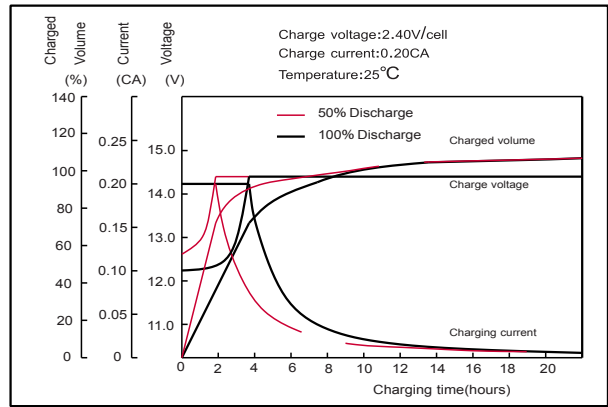

● Effect of temperature on capacity

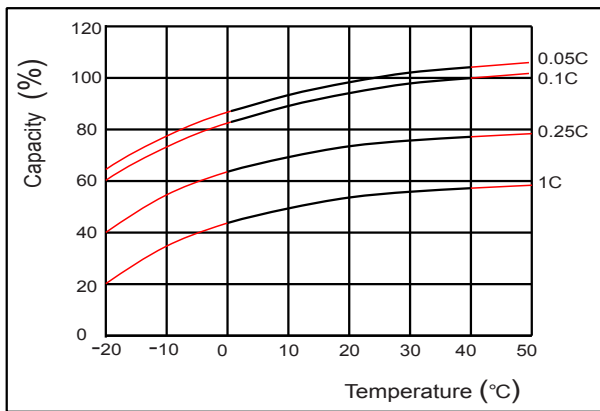

● Self-discharge characteristics

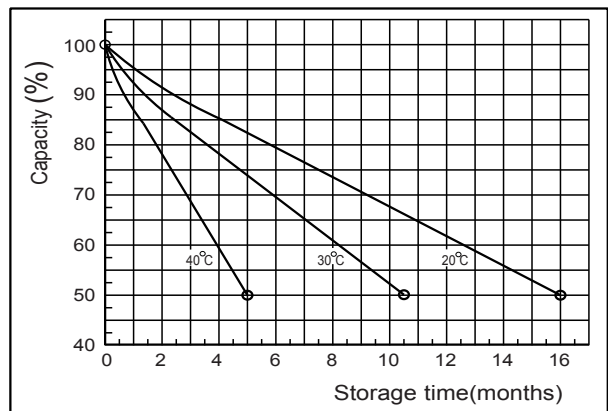

● Floating life on temperature

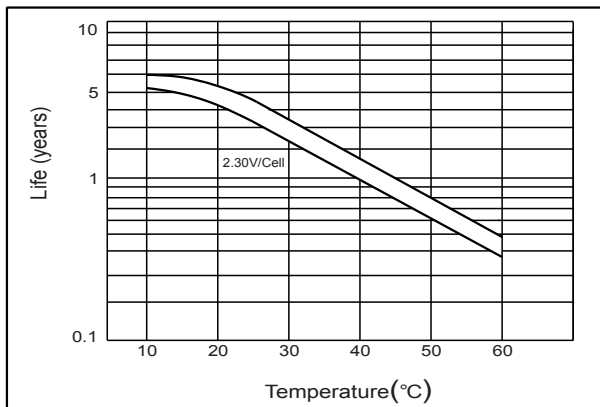

● Cycle life on D.O.D.(25°C)

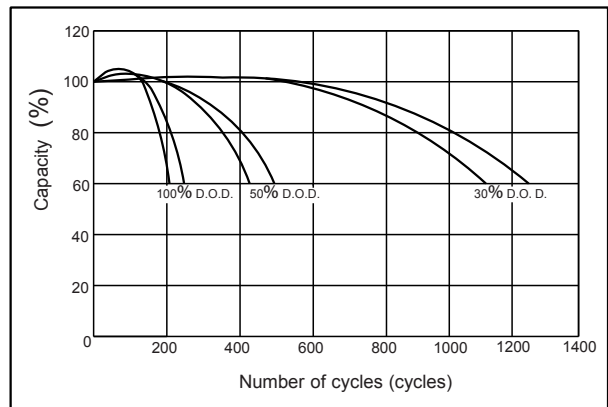

● The relationship for OCV and Capacity (25°C)

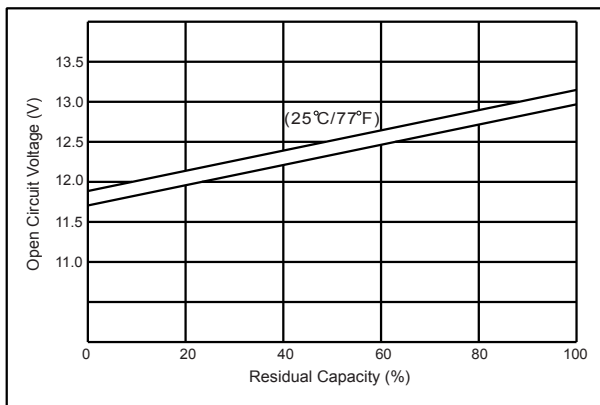

● The relationship for Charging voltage and Temperature

