

NP12-17Ah 12V17Ah

Specifications

Nominal Voltage		12V
Rated capacity (20 hour rate)		17Ah
Dimensions	Length	181±2mm(7.13inch)
	Width	77±1mm(3.03inch)
	Height	167±2mm(6.57inch)
	Total Height	167±2mm(6.57inch)
Approx. Weight		5.0kg(11.0lbs)±4%



Outer dimensions (mm)

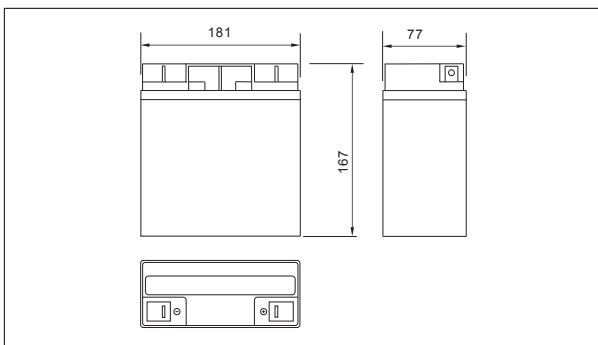

Terminal Type (mm)

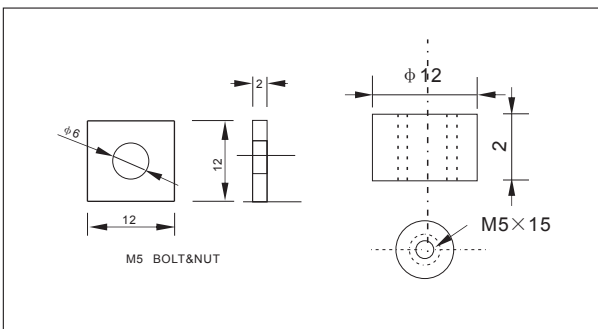

Characteristics

Capacity (25°C)	20HR(10.5V)	17Ah
	10HR(10.5V)	16Ah
	1HR(9.60V)	10.5Ah
Terminal type		T3/T12
Internal resistance (Fully charged, 25°C)		Approx. 17m Ω
Capacity affected by temperature (20HR)	40°C	102%
	25°C	100%
	0°C	85%
	-15°C	65%
Self-discharge (25°C)	3month	Remaining Capacity:91%
	6month	Remaining Capacity:82%
	12month	Remaining Capacity:65%
Nominal operating temperature		25°C ±3°C(77°F ±5°F)
Operating temperature range	Discharge	-15°C~50°C(5°F~122°F)
	Charge	-10°C~50°C(14°F~122°F)
	Storage	-20°C~50°C(-4°F~122°F)
Float charging voltage(25°C)		13.50 to 13.80V Temperature compensation: -18mV/°C
Cyclic charging voltage(25°C)		14.50 to 15.00V Temperature compensation: -30mV/°C
Maximum charging current		5.1A
Maximum discharge current		255A(5 sec.)
Designed floating life(20°C)		5 years

Construction

Component	Positive plate	Negative plate	Container	Cover	Separator	Electrolyte	Safety valve	Terminal
Raw material	Lead dioxide	Lead	ABS	ABS	AGM	Sulfuric acid	Rubber	Copper

Constant Current Discharge Characteristics Unit:A(25°C,77°F)

F.V/Time	5min	10min	15min	30min	60min	2h	3h	4h	5h	10h	20h
9.60V	64.9	41.1	32.1	18.1	11.1	6.09	4.21	3.49	2.97	1.61	0.86
9.90V	63.0	39.9	31.4	17.7	11.0	6.06	4.19	3.46	2.95	1.60	0.86
10.2V	60.4	38.3	30.2	17.2	10.7	6.00	4.16	3.44	2.93	1.60	0.86
10.5V	57.8	36.6	29.2	16.8	10.5	5.91	4.13	3.42	2.91	1.59	0.85
10.8V	54.5	34.6	27.6	16.2	10.2	5.76	4.01	3.31	2.82	1.55	0.83

Constant Power Discharge Characteristics Unit:W(25°C,77°F)

F.V/Time	5min	10min	15min	30min	60min	2h	3h	4h	5h	10h	20h
9.60V	725	464	366	207	129	71.3	50.1	41.5	35.4	19.3	10.4
9.90V	703	450	357	203	127	70.8	49.8	41.3	35.2	19.2	10.3
10.2V	674	432	344	197	124	70.2	49.4	41.0	35.0	19.1	10.3
10.5V	645	413	333	192	121	69.2	49.1	40.7	34.7	19.0	10.2
10.8V	609	390	315	185	118	67.4	47.6	39.5	33.7	18.7	10.0

Note: The above characteristics data can be obtained within three charge or discharge cycles.

NP12-17Ah 12V17Ah

● Discharge characteristics(25°C)

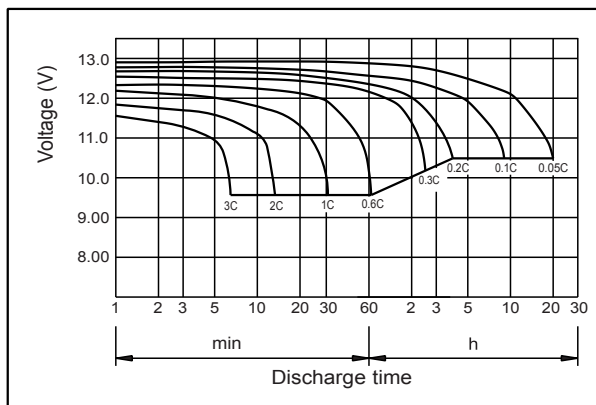

● Charging characteristics (25°C)

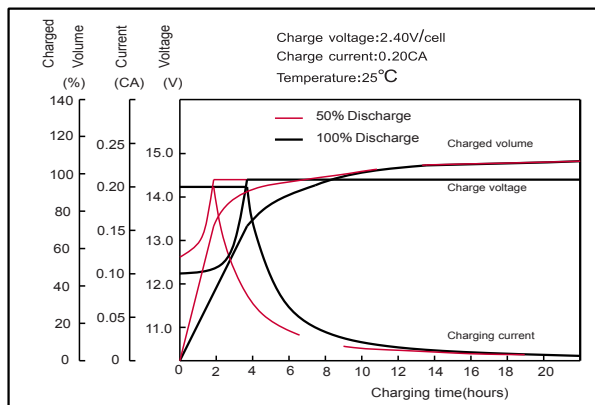

● Effect of temperature on capacity

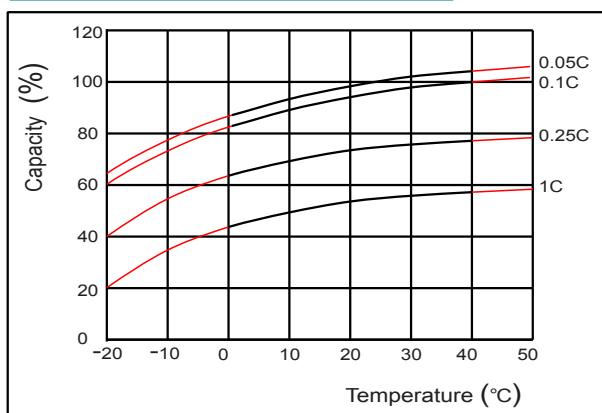

● Self-discharge characteristics

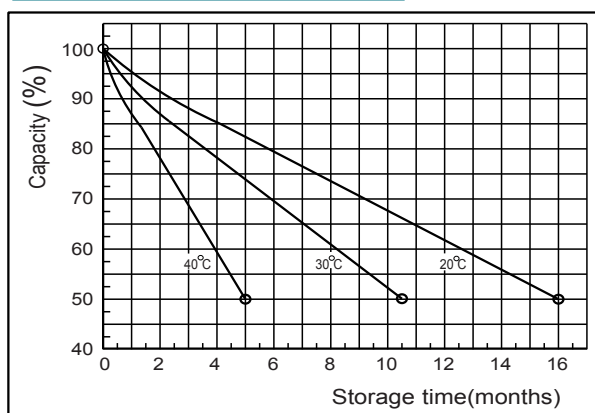

● Floating life on temperature

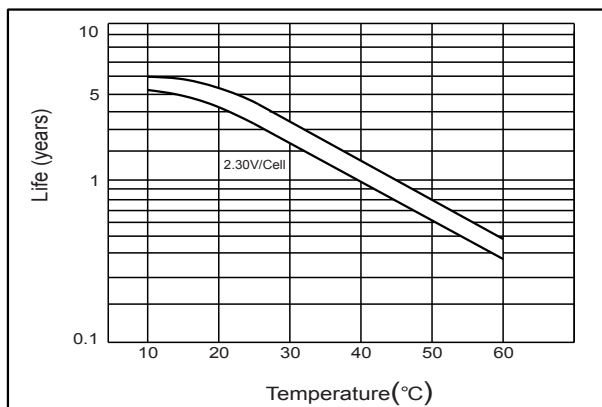

● Cycle life on D.O.D.(25°C)

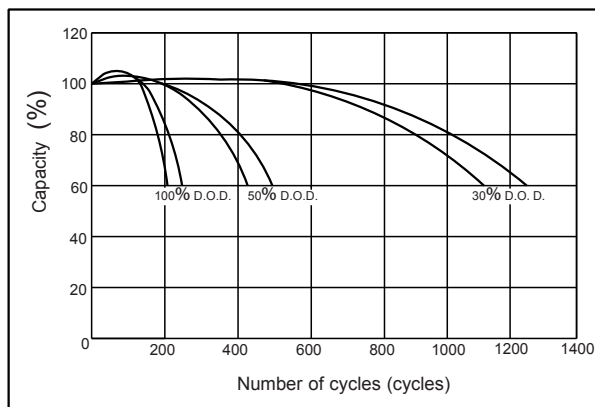

● The relationship for OCV and Capacity (25°C)

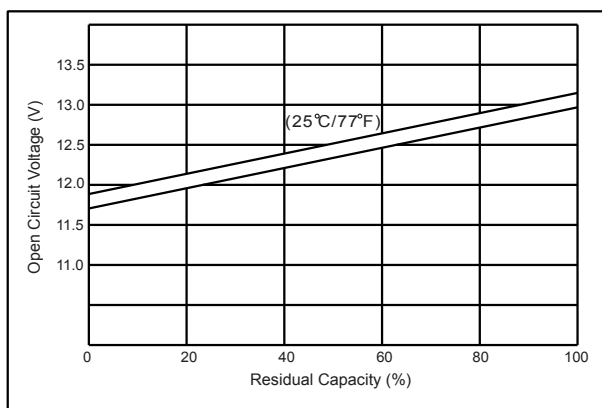

● The relationship for Charging voltage and Temperature

