

NP12-24Ah 12V24Ah



● **Specifications**

Nominal Voltage		12V
Rated capacity (20 hour rate)		24Ah
Dimensions	Length	166±2mm(6.54inch)
	Width	175±2mm(6.89inch)
	Height	125±2mm(4.92inch)
	Total Height	125±2mm(4.92inch)
Approx. Weight		7.4kg(16.3lbs)±4%

● **Outer dimensions (mm)**

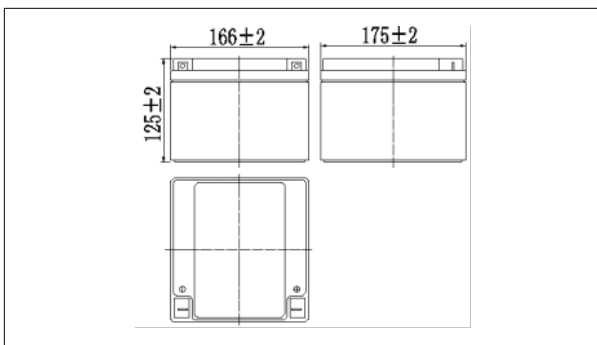

● **Terminal Type (mm)**

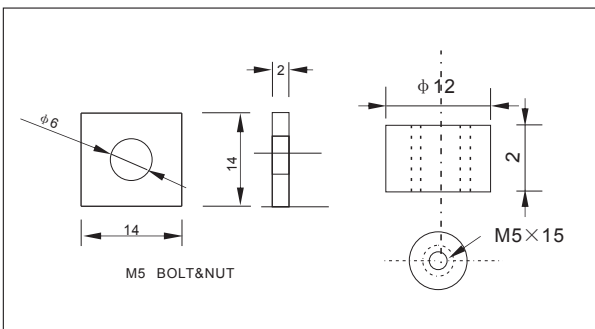

● **Characteristics**

Capacity (25°C)	20HR(10.5V)	24Ah
	10HR(10.5V)	22Ah
	1HR(9.60V)	15Ah
Terminal type		T4/T12
Internal resistance (Fully charged, 25°C)		Approx. 14m Ω
Capacity affected by temperature (20HR)	40°C	102%
	25°C	100%
	0°C	85%
	-15°C	65%
Self-discharge (25°C)	3month	Remaining Capacity:91%
	6month	Remaining Capacity:82%
	12month	Remaining Capacity:65%
Nominal operating temperature		25°C ±3°C(77°F ±5°F)
Operating temperature range	Discharge	-15°C~50°C(5°F~122°F)
	Charge	-10°C~50°C(14°F~122°F)
	Storage	-20°C~50°C(-4°F~122°F)
Float charging voltage(25°C)		13.50 to 13.80V Temperature compensation: -18mV/°C
Cyclic charging voltage(25°C)		14.50 to 15.00V Temperature compensation: -30mV/°C
Maximum charging current		7.2A
Maximum discharge current		360A(5 sec.)
Designed floating life(20°C)		5 years

● **Construction**

Component	Positive plate	Negative plate	Container	Cover	Separator	Electrolyte	Safety valve	Terminal
Raw material	Lead dioxide	Lead	ABS	ABS	AGM	Sulfuric acid	Rubber	Copper

● **Constant Current Discharge Characteristics Unit:A(25°C,77°F)**

F.V/Time	5min	10min	15min	30min	60min	2h	3h	4h	5h	10h	20h
9.60V	89.8	56.9	44.5	25.0	15.4	8.60	5.95	4.92	4.19	2.27	1.22
9.90V	87.2	55.2	43.4	24.5	15.2	8.55	5.91	4.89	4.16	2.26	1.21
10.2V	83.6	52.9	41.8	23.8	14.8	8.47	5.87	4.86	4.13	2.25	1.21
10.5V	80.0	50.7	40.4	23.2	14.5	8.34	5.83	4.82	4.10	2.24	1.20
10.8V	75.5	47.8	38.2	22.4	14.0	8.13	5.66	4.68	3.98	2.19	1.18

● **Constant Power Discharge Characteristics Unit:W(25°C,77°F)**

F.V/Time	5min	10min	15min	30min	60min	2h	3h	4h	5h	10h	20h
9.60V	1003	642	507	287	178	101	70.7	58.6	50.0	27.3	14.6
9.90V	973	623	495	281	176	100	70.3	58.3	49.7	27.2	14.6
10.2V	932	597	476	273	171	99.1	69.8	57.9	49.3	27.0	14.5
10.5V	892	571	460	266	168	97.6	69.3	57.5	49.0	26.9	14.4
10.8V	842	539	436	256	163	95.2	67.2	55.7	47.5	26.3	14.1

Note: The above characteristics data can be obtained within three charge or discharge cycles.

NP12-24Ah 12V24Ah

● Discharge characteristics(25°C)

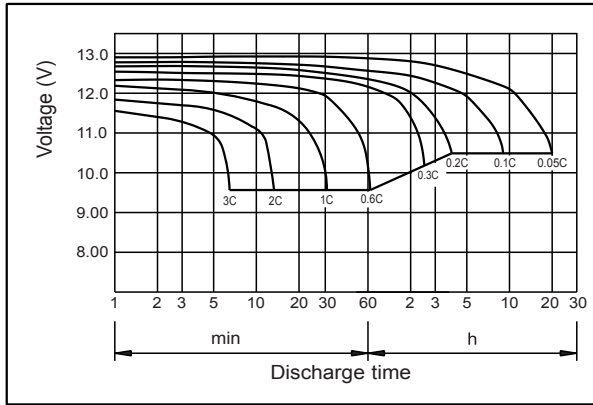

● Charging characteristics (25°C)

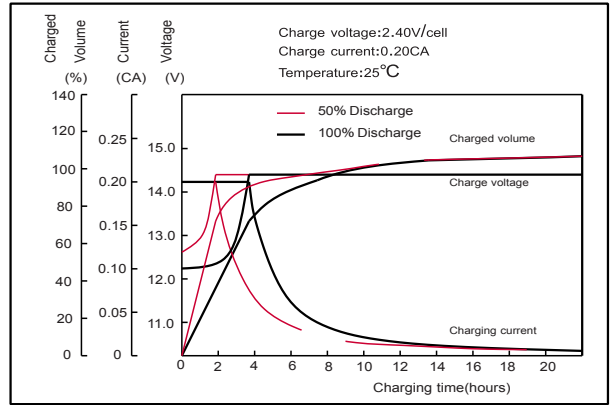

● Effect of temperature on capacity

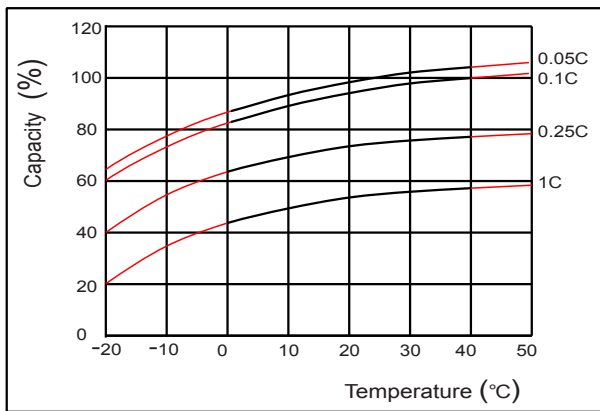

● Self-discharge characteristics

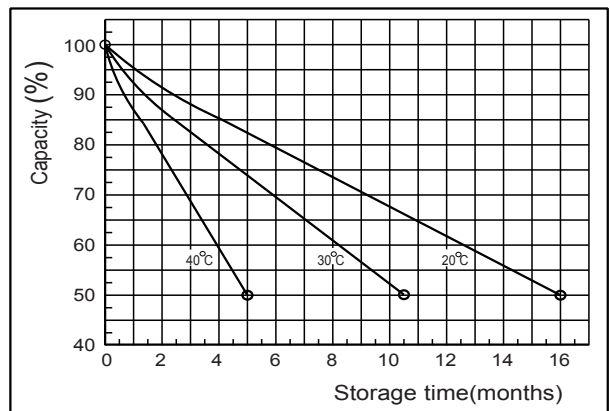

● Floating life on temperature

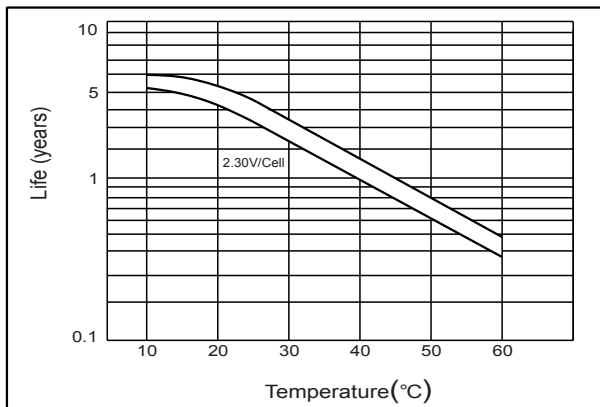

● Cycle life on D.O.D.(25°C)

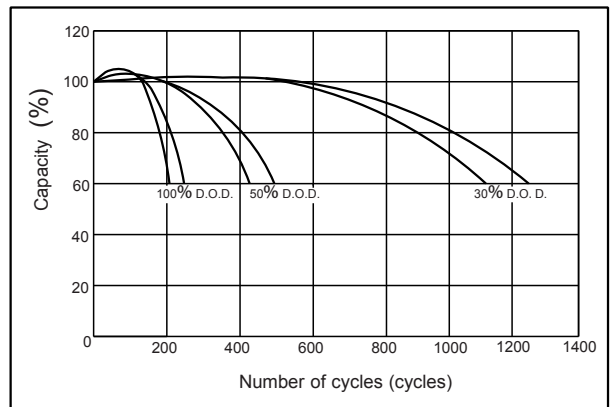

● The relationship for OCV and Capacity (25°C)

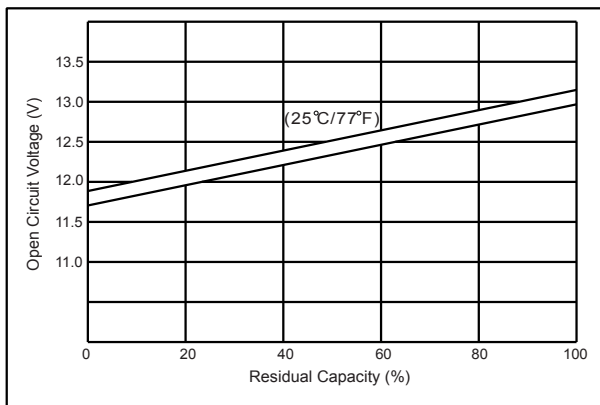

● The relationship for Charging voltage and Temperature

