

NP12-28Ah 12V28Ah

● **Specifications**

Nominal Voltage		12V
Rated capacity (20 hour rate)		28Ah
Dimensions	Length	166±2mm(6.54inch)
	Width	175±2mm(6.89inch)
	Height	125±2mm(4.92inch)
	Total Height	125±2mm(4.92inch)
Approx. Weight		8.8kg(19.4lbs)±4%



● **Outer dimensions (mm)**

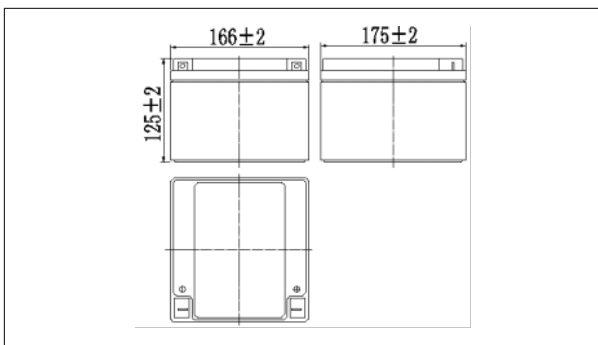

● **Terminal Type (mm)**

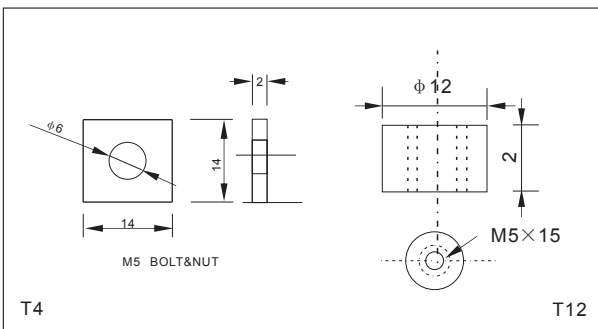

● **Characteristics**

Capacity (25°C)	20HR(10.5V)	28Ah
	10HR(10.5V)	26Ah
	1HR(9.60V)	17Ah
Terminal type		T4/T12
Internal resistance (Fully charged,25°C)		Approx. 10m Ω
Capacity affected by temperature (20HR)	40°C	102%
	25°C	100%
	0°C	85%
	-15°C	65%
Self-discharge (25°C)	3 months	Remaining Capacity:91%
	6 months	Remaining Capacity:82%
	12 months	Remaining Capacity:65%
Nominal operating temperature		25°C ±3°C(77°F ±5°F)
Operating temperature range	Discharge	-15°C~50°C(5°F~122°F)
	Charge	-10°C~50°C(14°F~122°F)
	Storage	-20°C~50°C(-4°F~122°F)
Float charging voltage(25°C)		13.50 to 13.80V Temperature compensation: -18mV/°C
Cyclic charging voltage(25°C)		14.50 to 15.00V Temperature compensation: -30mV/°C
Maximum charging current		8.4A
Maximum discharge current		360A(5 sec.)
Designed floating life(20°C)		5 years

● **Construction**

Component	Positive plate	Negative plate	Container	Cover	Separator	Electrolyte	Safety valve	Terminal
Raw material	Lead dioxide	Lead	ABS	ABS	AGM	Sulfuric acid	Rubber	Copper

● **Constant Current Discharge Characteristics Unit:A(25°C,77°F)**

F.V/Time	5min	10min	15min	30min	60min	2h	3h	4h	5h	10h	20h
9.60V	105	66.4	51.9	29.2	18.0	10.0	6.94	5.74	4.88	2.65	1.42
9.90V	102	64.4	50.6	28.6	17.7	9.97	6.90	5.71	4.86	2.64	1.42
10.2V	97.5	61.8	48.7	27.8	17.3	9.88	6.85	5.67	4.82	2.63	1.41
10.5V	93.3	59.1	47.1	27.1	16.9	9.74	6.80	5.63	4.79	2.61	1.40
10.8V	88.0	55.8	44.6	26.1	16.4	9.49	6.60	5.46	4.64	2.56	1.37

● **Constant Power Discharge Characteristics Unit:W(25°C,77°F)**

F.V/Time	5min	10min	15min	30min	60min	2h	3h	4h	5h	10h	20h
9.60V	1170	749	591	335	208	117	82.4	68.4	58.3	31.8	17.1
9.90V	1135	727	577	328	205	117	82.0	68.0	58.0	31.7	17.0
10.2V	1088	697	556	318	200	116	81.4	67.5	57.6	31.5	16.9
10.5V	1041	667	537	310	196	114	80.8	67.0	57.2	31.3	16.8
10.8V	983	629	508	299	190	111	78.4	65.0	55.5	30.7	16.5

Note: The above characteristics data can be obtained within three charge or discharge cycles.

NP12-28Ah 12V28Ah

● Discharge characteristics(25°C)



● Charging characteristics (25°C)

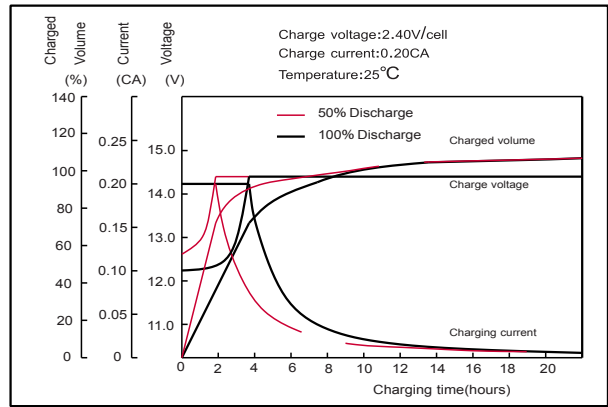

● Effect of temperature on capacity

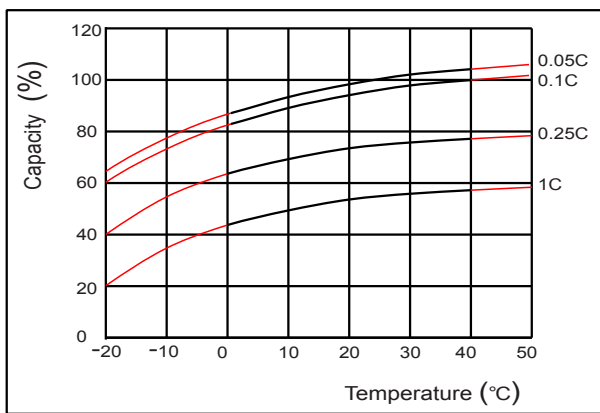

● Self-discharge characteristics

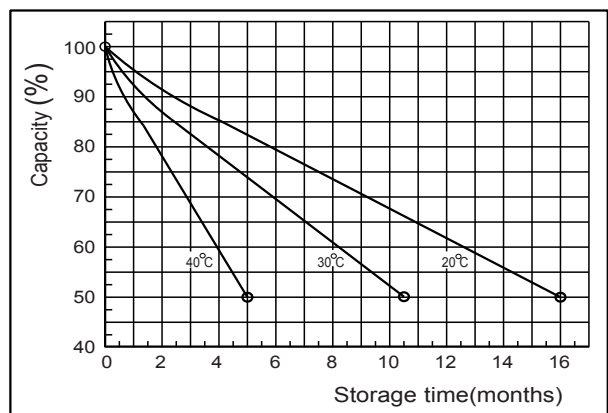

● Floating life on temperature

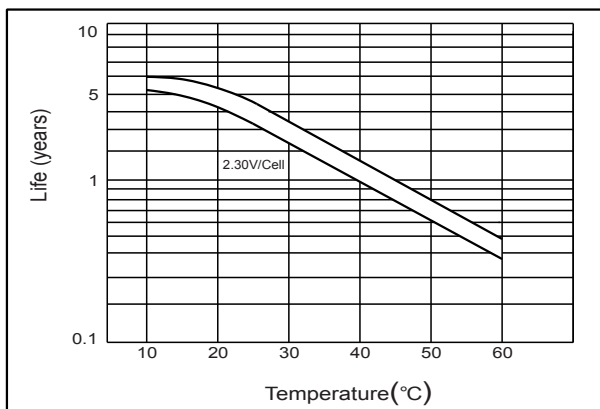

● Cycle life on D.O.D.(25°C)

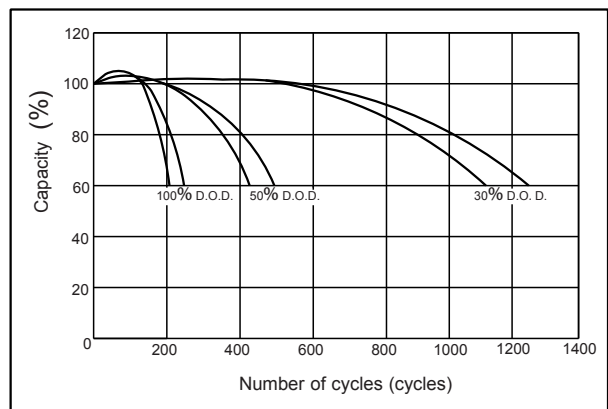

● The relationship for OCV and Capacity (25°C)

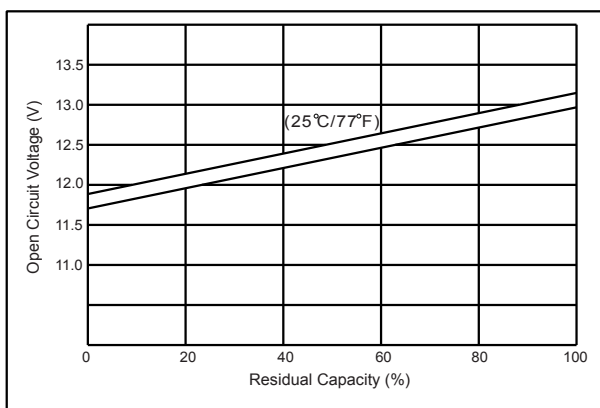

● The relationship for Charging voltage and Temperature

