

NP6-100Ah 6V100Ah

● Specifications

Nominal Voltage		6V
Rated capacity (10 hour rate)		100Ah
Dimensions	Length	194±2mm(7.64inch)
	Width	170±2mm(6.691inch)
	Height	205±2mm(8.07inch)
	Total Height	210±2mm(8.27inch)
Approx. Weight		14.8kg(32.6lbs)±4%

● Outer dimensions (mm)

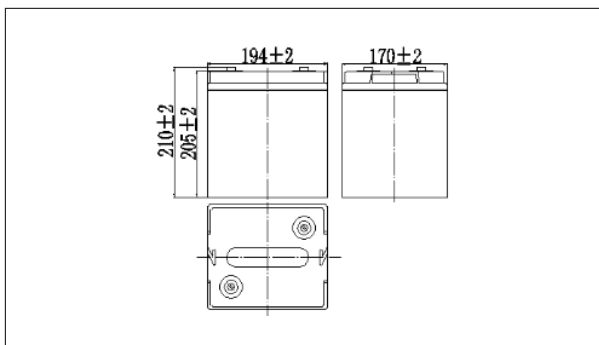

● Terminal Type (mm)

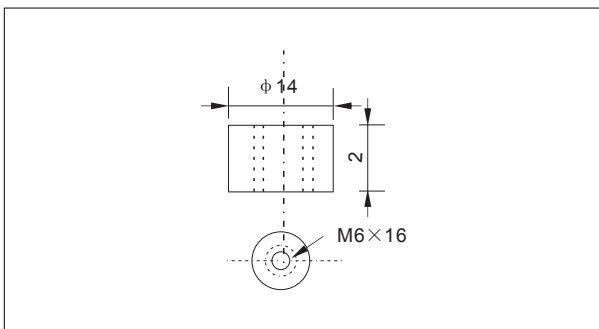

● Construction

Component	Positive plate	Negative plate	Container	Cover	Separator	Electrolyte	Safety valve	Terminal
Raw material	Lead dioxide	Lead	ABS	ABS	AGM	Sulfuric acid	Rubber	Copper

● Constant Current Discharge Characteristics Unit:A(25°C,77°F)

F.V/Time	10min	15min	30min	60min	2h	3h	4h	5h	8h	10h	20h
4.80V	218	168	101	61.8	36.5	26.3	21.0	18.0	12.3	10.2	5.40
4.95V	211	164	98.5	60.9	36.3	26.2	20.9	17.8	12.3	10.2	5.38
5.10V	203	158	95.5	59.3	36.0	26.0	20.7	17.7	12.2	10.1	5.37
5.25V	194	153	93.2	57.5	35.5	25.8	20.6	17.6	12.1	10.1	5.34
5.40V	183	144	89.7	55.6	34.6	25.0	20.0	17.1	11.7	10.0	5.30

● Constant Power Discharge Characteristics Unit:W(25°C,77°F)

F.V/Time	10min	15min	30min	60min	2h	3h	4h	5h	8h	10h	20h
4.80V	1177	922	564	352	212	155	124	106	73.3	60.8	32.4
4.95V	1142	900	553	347	210	154	123	105	72.9	60.7	32.3
5.10V	1095	867	536	338	208	153	122	105	72.4	60.5	32.2
5.25V	1048	837	523	328	205	152	121	104	71.9	60.1	32.0
5.40V	989	793	503	317	200	147	117	101	69.7	59.7	31.8

Note: The above characteristics data can be obtained within three charge or discharge cycles.

● Characteristics

Capacity (25°C)	10HR(5.40V)	100Ah
	3HR(5.40V)	75Ah
	1HR(5.25V)	55Ah
Terminal type		T14
Internal resistance (Fully charged,25°C)		Approx.3m Ω
Capacity affected by temperature (10HR)	40°C	102%
	25°C	100%
	0°C	85%
	-15°C	65%
Self-discharge (25°C)	3month	Remaining Capacity:91%
	6month	Remaining Capacity:82%
	12month	Remaining Capacity:65%
Nominal operating temperature		25°C ±3°C(77°F ±5°F)
Operating temperature range	Discharge	-15°C~50°C(5°F~122°F)
	Charge	-10°C~50°C(14°F~122°F)
	Storage	-20°C~50°C(-4°F~122°F)
Float charging voltage(25°C)		6.75 to 6.90V Temperature compensation: -9mV/°C
Cyclic charging voltage(25°C)		7.25 to 7.50V Temperature compensation: -15mV/°C
Maximum charging current		30A
Terminal material		Copper
Maximum discharge current		800A(5 sec.)
Designed floating life(20°C)		10years

NP6-100Ah 6V100Ah

Discharge characteristics(25°C)

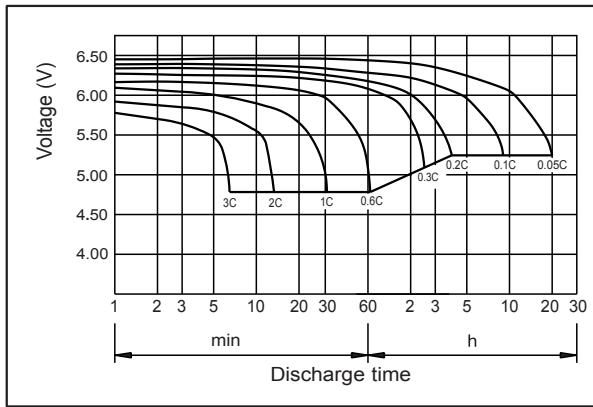

Charging characteristics(25°C)

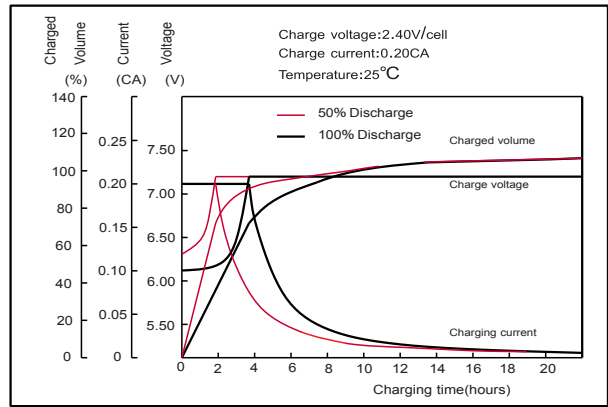

Effect of temperature on capacity



Self-discharge characteristics

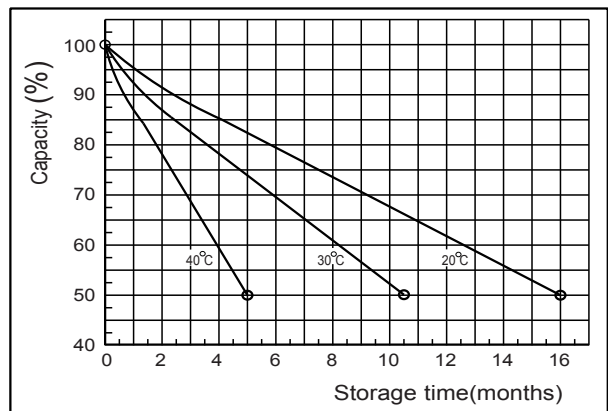

Floating life on temperature

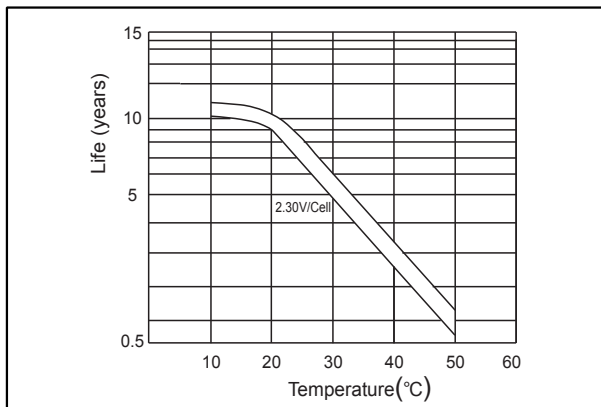

Cycle life on D.O.D (25°C)

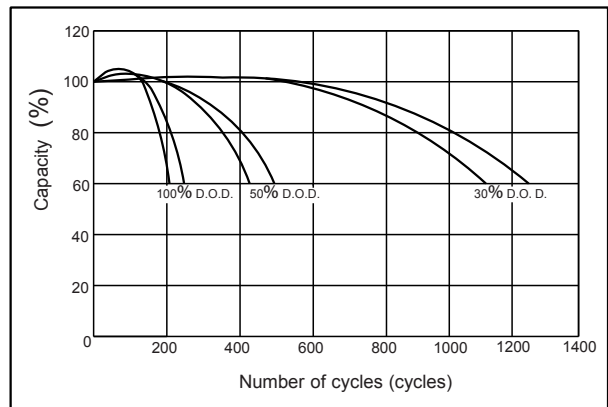

The relationship for OCV and Capacity (25°C)

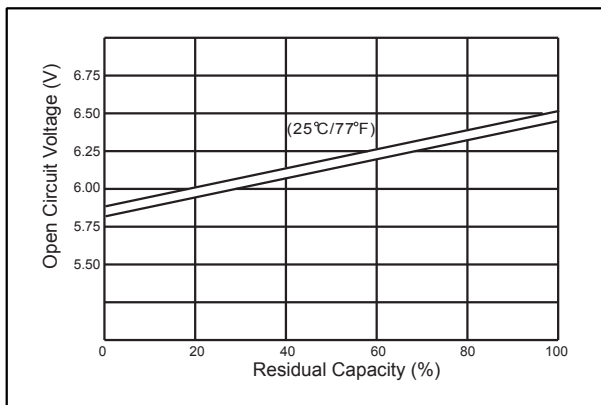

The relationship for Charging voltage and Temperature

