

NP12-75Ah 12V75Ah



● **Specifications**

Nominal Voltage		12V
Rated capacity (10 hour rate)		75Ah
Dimensions	Length	260±2mm(10.24inch)
	Width	168±2mm(6.61inch)
	Height	211±2mm(8.31inch)
	Total Height	215±2mm(8.46inch)
Approx. Weight		23.5kg(51.8lbs)±3%

● **Outer dimensions (mm)**

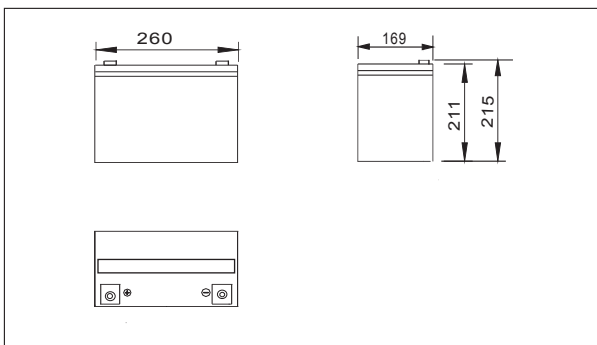

● **Terminal Type (mm)**

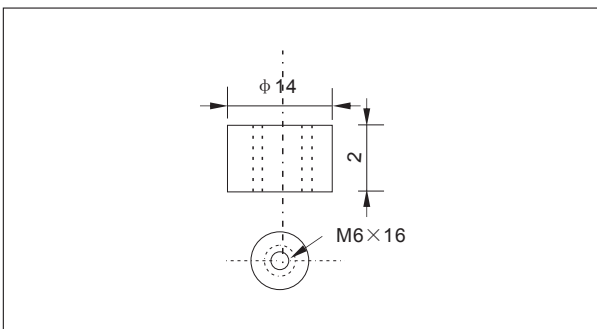

● **Construction**

Component	Positive plate	Negative plate	Container	Cover	Separator	Electrolyte	Safety valve	Terminal
Raw material	Lead dioxide	Lead	ABS	ABS	AGM	Sulfuric acid	Rubber	Copper

● **Constant Current Discharge Characteristics Unit:A(25°C,77°F)**

F.V/Time	10min	15min	30min	60min	2h	3h	4h	5h	8h	10h	20h
9.60V	164	126	75.4	46.4	27.4	19.7	15.8	13.5	9.26	7.64	4.05
9.90V	159	123	73.9	45.7	27.2	19.6	15.7	13.4	9.20	7.62	4.04
10.2V	152	118	71.6	44.5	27.0	19.5	15.6	13.3	9.14	7.60	4.03
10.5V	146	114	69.9	43.1	26.6	19.4	15.5	13.2	9.08	7.55	4.00
10.8V	137	108	67.3	41.7	25.9	18.8	15.0	12.8	8.80	7.50	3.98

● **Constant Power Discharge Characteristics Unit:W(25°C,77°F)**

F.V/Time	10min	15min	30min	60min	2h	3h	4h	5h	8h	10h	20h
9.60V	1766	1383	846	528	317	232	185	159	110	91.2	48.6
9.90V	1713	1350	829	520	315	231	184	158	109	91.0	48.5
10.2V	1642	1300	803	507	313	229	183	157	109	90.7	48.3
10.5V	1572	1256	784	491	308	228	182	156	108	90.2	48.0
10.8V	1483	1190	755	476	300	221	176	151	105	89.6	47.7

Note: The above characteristics data can be obtained within three charge or discharge cycles.

● **Characteristics**

Capacity (25°C)	10HR(10.8V)	75Ah
	3HR(10.8V)	55.5Ah
	1HR(10.5V)	41.5Ah
Terminal type		T14
Internal resistance (Fully charged,25°C)		Approx.6m Ω
Capacity affected by temperature (10HR)	40°C	102%
	25°C	100%
	0°C	85%
	-15°C	65%
Self-discharge (25°C)	3month	Remaining Capacity:91%
	6month	Remaining Capacity:82%
	12month	Remaining Capacity:65%
Nominal operating temperature		25°C ±3°C(77°F ±5°F)
Operating temperature range	Discharge	-15°C~50°C(5°F~122°F)
	Charge	-10°C~50°C(14°F~122°F)
	Storage	-20°C~50°C(-4°F~122°F)
Float charging voltage(25°C)		13.50 to 13.80V Temperature compensation: -18mV/°C
Cyclic charging voltage(25°C)		14.50 to 15.00V Temperature compensation: -30mV/°C
Maximum charging current		22.5A
Terminal material		Copper
Maximum discharge current		700A(5 sec.)
Designed floating life(20°C)		10years

NP12-75Ah 12V75Ah

● **Discharge characteristics(25°C)**



● **Charging characteristics (25°C)**

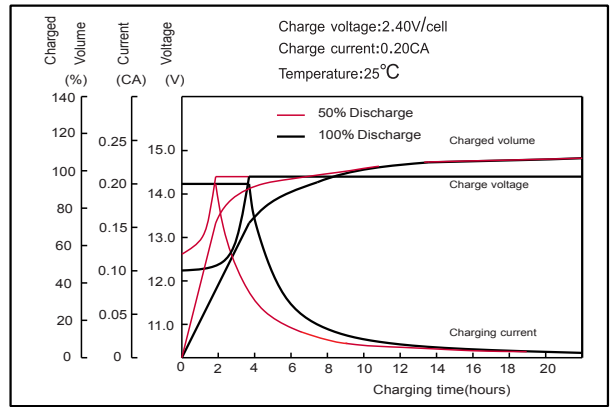

● **Temperature effects on Capacity**



● **Self-discharge characteristics**

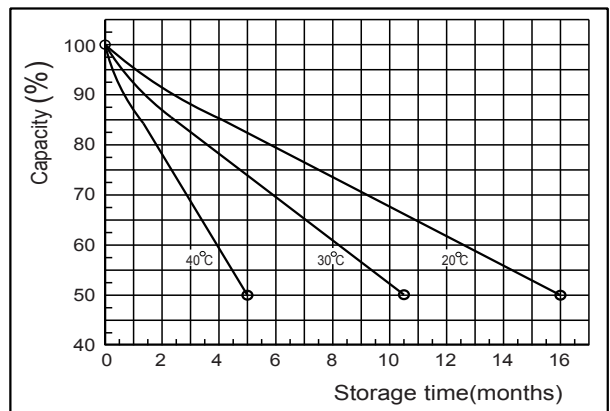

● **Floating life on Temperature**

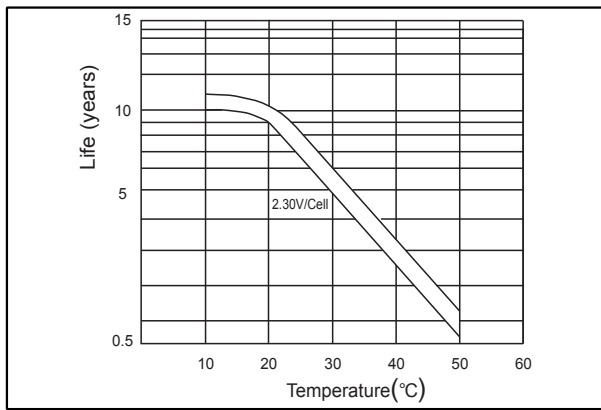

● **Cycle life on D.O.D (25°C)**

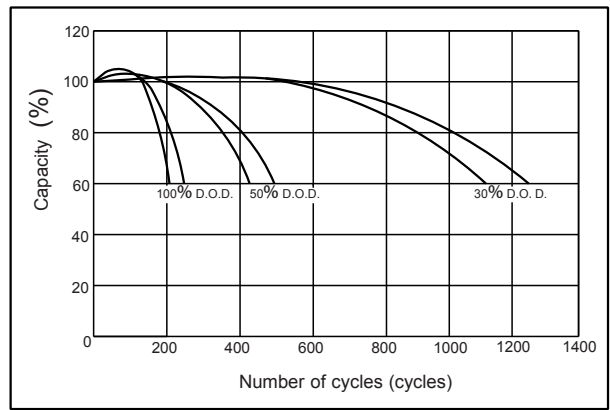

● **The relationship for OCV and Capacity (25°C)**

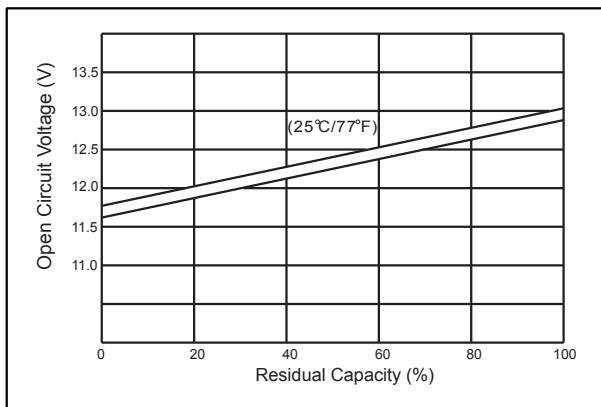

● **The relationship for Charging voltage and Temperature**

