

# NP12-80Ah 12V80Ah



● Specifications

Nominal Voltage		12V
Rated capacity (10 hour rate)		80Ah
Dimensions	Length	260±2mm(10.24inch)
	Width	168±2mm(6.61inch)
	Height	211±2mm(8.31inch)
	Total Height	215±2mm(8.46inch)
Approx. Weight		24.2kg(53.3lbs)±3%

● Outer dimensions (mm)

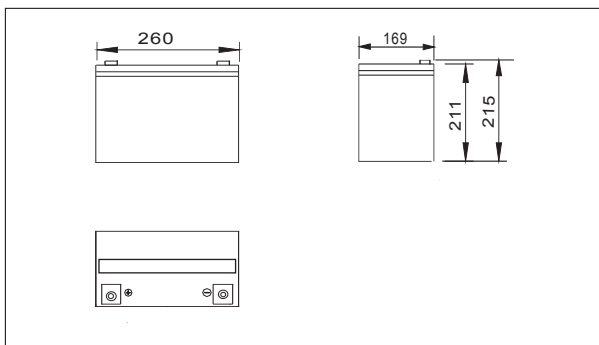

● Terminal Type (mm)

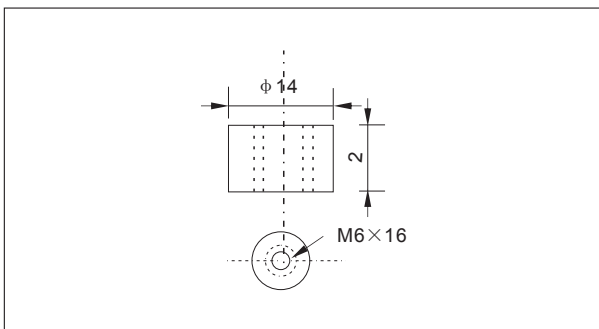

● Construction

Component	Positive plate	Negative plate	Container	Cover	Separator	Electrolyte	Safety valve	Terminal
Raw material	Lead dioxide	Lead	ABS	ABS	AGM	Sulfuric acid	Rubber	Copper

● Constant Current Discharge Characteristics Unit:A(25°C,77°F)

F.V/Time	10min	15min	30min	60min	2h	3h	4h	5h	8h	10h	20h
9.60V	174	134	80.4	49.4	29.2	21.1	16.8	14.4	9.87	8.14	4.32
9.90V	169	131	78.8	48.7	29.1	20.9	16.7	14.3	9.82	8.13	4.31
10.2V	162	126	76.4	47.5	28.8	20.8	16.6	14.2	9.75	8.10	4.30
10.5V	155	122	74.5	46.0	28.4	20.6	16.5	14.1	9.68	8.06	4.27
10.8V	146	116	71.8	44.5	27.6	20.0	16.0	13.7	9.39	8.00	4.24

● Constant Power Discharge Characteristics Unit:W(25°C,77°F)

F.V/Time	10min	15min	30min	60min	2h	3h	4h	5h	8h	10h	20h
9.60V	1884	1476	902	564	339	248	198	170	117	97.2	51.8
9.90V	1827	1440	884	555	337	246	197	169	117	97.0	51.7
10.2V	1752	1387	857	541	334	244	195	168	116	96.8	51.5
10.5V	1676	1340	836	524	329	243	194	166	115	96.2	51.2
10.8V	1582	1269	806	507	320	235	188	161	112	95.5	50.9

Note: The above characteristics data can be obtained within three charge or discharge cycles.

● Characteristics

Capacity (25°C)	10HR(10.8V)	80Ah
	3HR(10.8V)	60Ah
	1HR(10.5V)	44Ah
Terminal type		T14
Internal resistance (Fully charged,25°C)		Approx.5.5m Ω
Capacity affected by temperature (10HR)	40°C	102%
	25°C	100%
	0°C	85%
	-15°C	65%
Self-discharge (25°C)	3month	Remaining Capacity:91%
	6month	Remaining Capacity:82%
	12month	Remaining Capacity:65%
Nominal operating temperature		25°C ±3°C(77°F ±5°F)
Operating temperature range	Discharge	-15°C~50°C(5°F~122°F)
	Charge	-10°C~50°C(14°F~122°F)
	Storage	-20°C~50°C(-4°F~122°F)
Float charging voltage(25°C)		13.50 to 13.80V Temperature compensation: -18mV/°C
Cyclic charging voltage(25°C)		14.50 to 15.00V Temperature compensation: -30mV/°C
Maximum charging current		24A
Terminal material		Copper
Maximum discharge current		700A(5 sec.)
Designed floating life(20°C)		10years

## NP12-80Ah 12V80Ah

### ● Discharge characteristics(25°C)

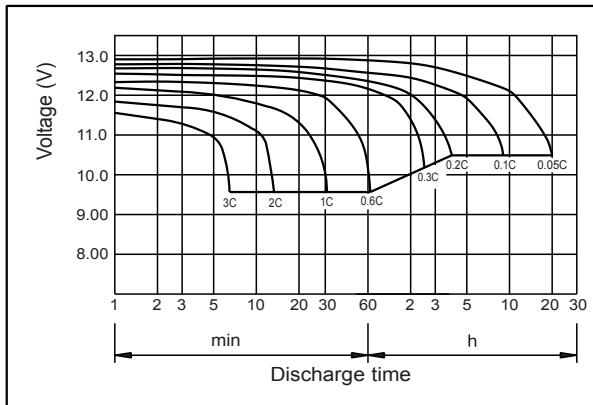

### ● Charging characteristics (25°C)

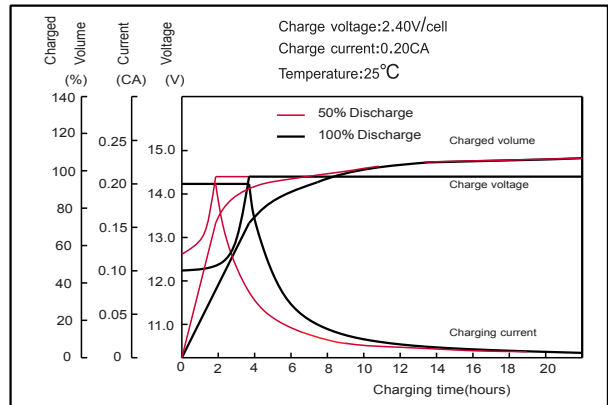

### ● Temperature effects on Capacity

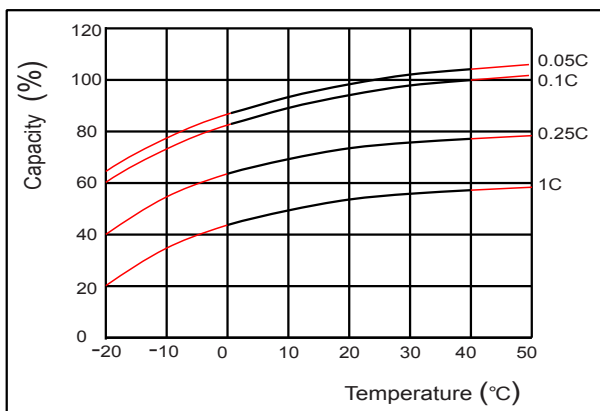

### ● Self-discharge characteristics

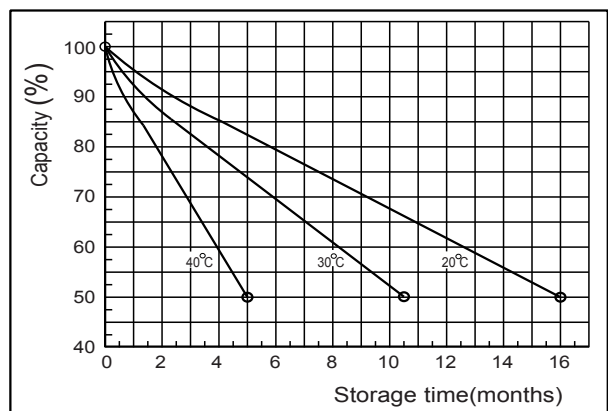

### ● Floating life on Temperature

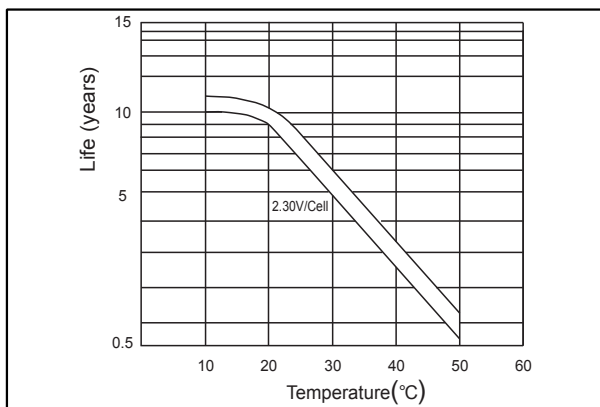

### ● Cycle life on D.O.D (25°C)

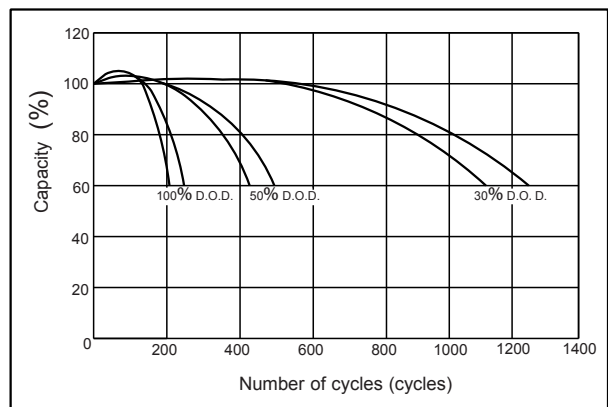

### ● The relationship for OCV and Capacity (25°C)

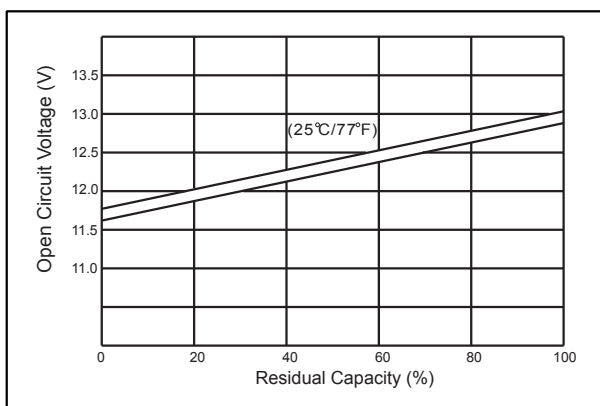

### ● The relationship for Charging voltage and Temperature

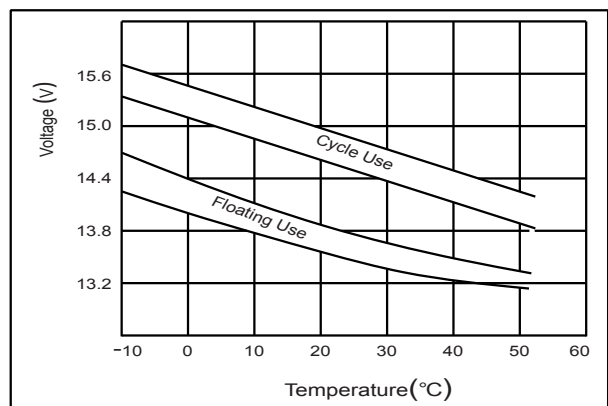

MH47211