

NP6-100Ah 6V100Ah

● **Specifications**

Nominal Voltage		6V
Rated capacity (10 hour rate)		100Ah
Dimensions	Length	194±2mm(7.64inch)
	Width	170±2mm(6.69inch)
	Height	205±2mm(8.07inch)
	Total Height	210±2mm(8.27inch)
Approx. Weight		16kg(35.3lbs)±3%

● **Outer dimensions (mm)**

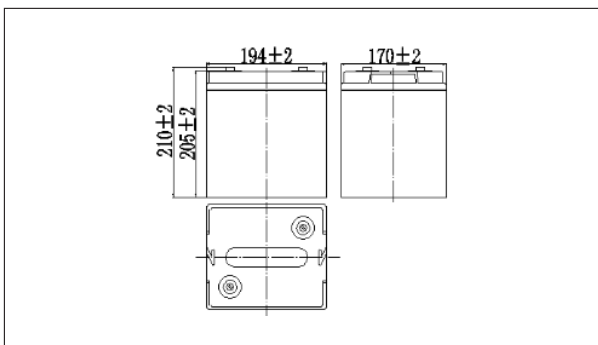

● **Terminal Type (mm)**

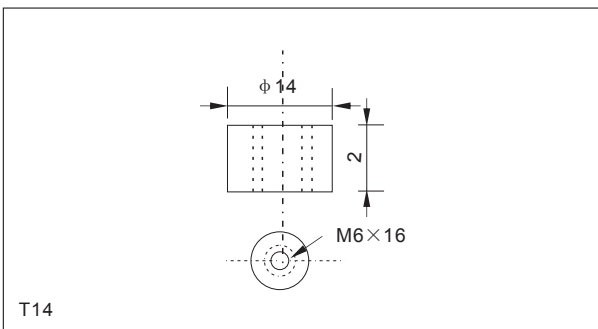

● **Characteristics**

Capacity (25°C)	10HR(5.40V)	100Ah
	3HR(5.40V)	75Ah
	1HR(5.25V)	57Ah
Terminal type		T14
Internal resistance (Fully charged,25°C)		Approx.2.8m Ω
Capacity affected by temperature (10HR)	40°C	102%
	25°C	100%
	0°C	85%
	-15°C	65%
Self-discharge (25°C)	3 months	Remaining Capacity:91%
	6 months	Remaining Capacity:82%
	12 months	Remaining Capacity:65%
Nominal operating temperature		25°C ±3°C(77°F ±5°F)
Operating temperature range	Discharge	-15°C~50°C(5°F~122°F)
	Charge	-10°C~50°C(14°F~122°F)
	Storage	-20°C~50°C(-4°F~122°F)
Float charging voltage(25°C)		6.75 to 6.90V Temperature compensation: -9mV/°C
Cyclic charging voltage(25°C)		7.25 to 7.50V Temperature compensation: -15mV/°C
Maximum charging current		30A
Maximum discharge current		800A(5 sec.)
Designed floating life(20°C)		10years

● **Construction**

Component	Positive plate	Negative plate	Container	Cover	Separator	Electrolyte	Safety valve	Terminal
Raw material	Lead dioxide	Lead	ABS	ABS	AGM	Sulfuric acid	Rubber	Copper

● **Constant Current Discharge Characteristics Unit:A(25°C,77°F)**

F.V/Time	10min	15min	30min	60min	2h	3h	4h	5h	8h	10h	20h
4.80V	225	173	104	63.7	37.6	27.1	21.6	18.5	12.7	10.5	5.56
4.95V	218	169	101	62.7	37.4	26.9	21.5	18.4	12.6	10.5	5.55
5.10V	209	163	98.3	61.1	37.1	26.8	21.4	18.3	12.6	10.4	5.53
5.25V	200	157	96.0	59.2	36.5	26.6	21.2	18.1	12.5	10.4	5.50
5.40V	189	149	92.4	57.3	35.6	25.8	20.6	17.6	12.1	10.3	5.46

● **Constant Power Discharge Characteristics Unit:W(25°C,77°F)**

F.V/Time	10min	15min	30min	60min	2h	3h	4h	5h	8h	10h	20h
4.80V	1213	950	581	363	218	159	127	109	75.5	62.6	33.3
4.95V	1176	927	569	357	217	158	127	109	75.1	62.5	33.3
5.10V	1128	893	552	348	215	157	126	108	74.5	62.3	33.2
5.25V	1079	863	538	337	211	156	125	107	74.0	61.9	33.0
5.40V	1019	817	519	327	206	152	121	104	71.8	61.5	32.8

Note: The above characteristics data can be obtained within three charge or discharge cycles.

NPD6-100Ah 6V100Ah

Discharge characteristics(25°C)

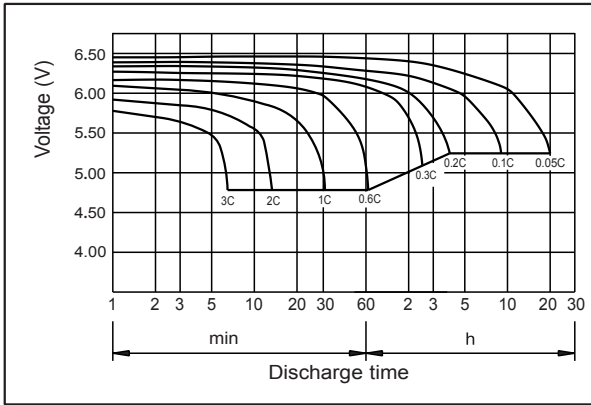

Charging characteristics(25°C)

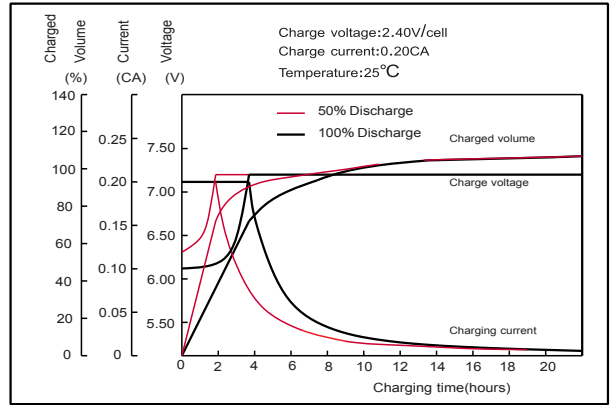

Effect of temperature on capacity

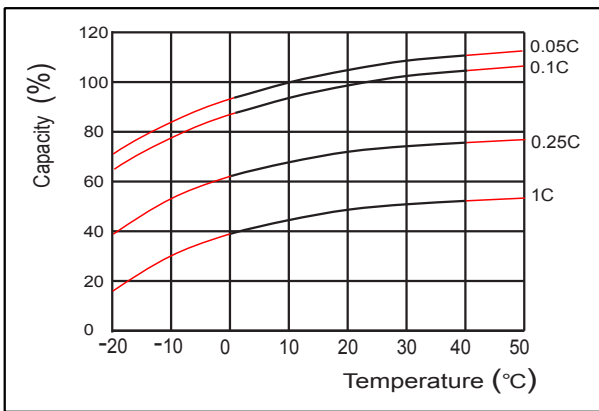

Self-discharge characteristics

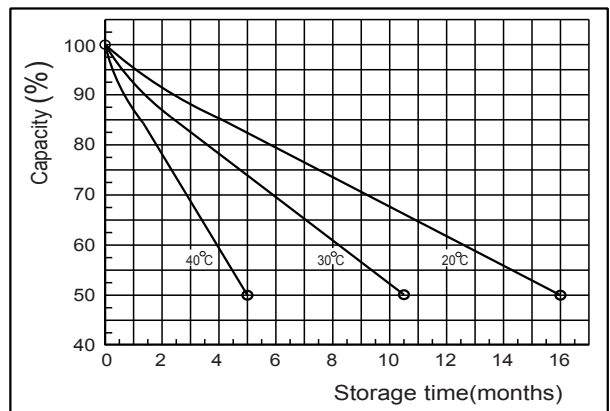

Floating life on temperature

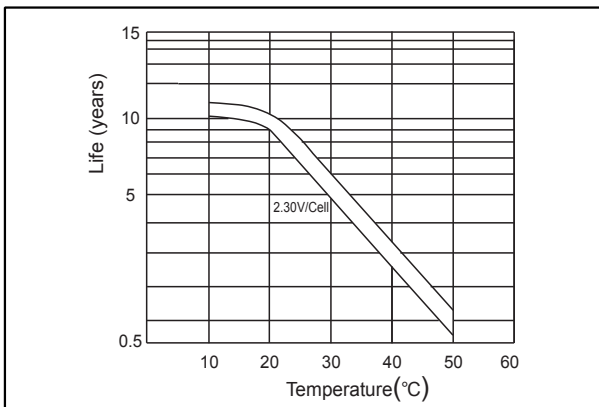

Cycle life on D.O.D (25°C)

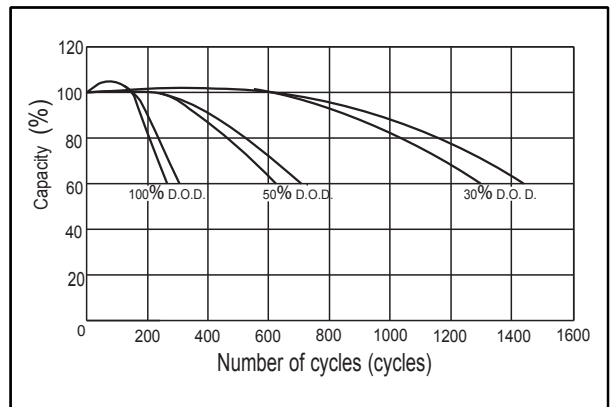

The relationship for OCV and Capacity (25°C)

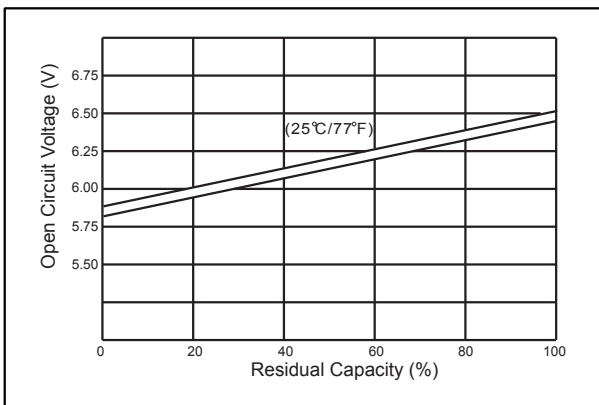

The relationship for Charging voltage and Temperature

