

NPD2-200Ah 2V200Ah



● **Specifications**

Nominal Voltage		2V
Rated capacity (10 hour rate)		200Ah
Dimensions	Length	171±2mm(6.73inch)
	Width	111±2mm(4.37inch)
	Height	330±2mm(12.99inch)
	Total Height	364±2mm(14.33inch)
Approx. Weight		14kg(30.9lbs)±3%

● **Outer dimensions (mm)**

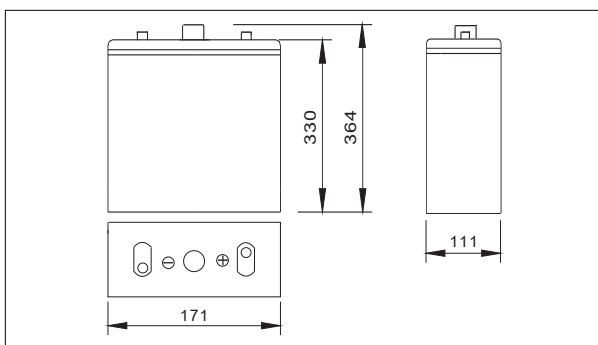

● **Terminal Type (mm)**

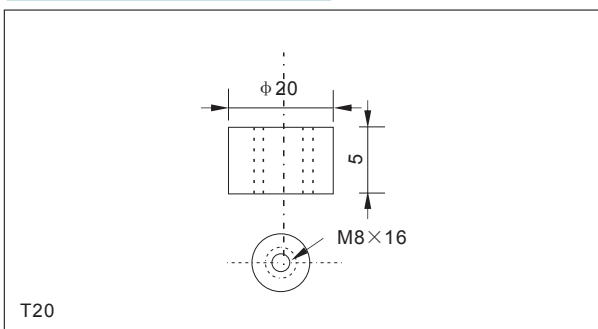

● **Characteristics**

Capacity (25°C)	10HR(1.8V)	200Ah
	3HR(1.80V)	159Ah
	1HR(1.75V)	116Ah
Terminal type		T20
Internal resistance (Fully charged,25°C)		Approx.0.9m Ω
Capacity affected by temperature (10HR)	40°C	102%
	25°C	100%
	0°C	85%
	-15°C	65%
Self-discharge (25°C)	3 months	Remaining Capacity:91%
	6 months	Remaining Capacity:82%
	12 months	Remaining Capacity:65%
Nominal operating temperature		25°C ±3°C(77°F ±5°F)
Operating temperature range	Discharge	-15°C~50°C(5°F~122°F)
	Charge	-10°C~50°C(14°F~122°F)
	Storage	-20°C~50°C(-4°F~122°F)
Float charging voltage(25°C)		2.25 to 2.30V Temperature compensation: -3mV/°C
Cyclic charging voltage(25°C)		2.40 to 2.50V Temperature compensation: -5mV/°C
Maximum charging current		40A
Maximum discharge current		1500A(5 sec.)
Designed floating life(20°C)		15 years

● **Construction**

Component	Positive plate	Negative plate	Container	Cover	Separator	Electrolyte	Safety valve	Terminal
Raw material	lead dioxide	Lead	ABS	ABS	AGM	Sulfuric acid	Rubber	Copper

● **Constant Current Discharge Characteristics Unit:A(25°C,77°F)**

F.V/Time	15min	30min	60min	2h	3h	4h	5h	6h	8h	10h	20h
1.60V	292	191	132	77.4	55.7	44.6	38.3	33.0	26.0	21.5	11.3
1.65V	285	187	128	76.9	55.4	44.3	38.1	32.8	25.9	21.4	11.3
1.70V	274	182	124	76.2	55.0	44.0	37.9	32.6	25.7	21.4	11.3
1.75V	265	177	120	75.1	54.6	43.7	37.6	32.3	25.5	21.3	11.2
1.80V	251	171	116	73.2	53.0	42.4	36.5	31.4	24.7	21.1	11.1

● **Constant Power Discharge Characteristics Unit:W(25°C,77°F)**

F.V/Time	15min	30min	60min	2h	3h	4h	5h	6h	8h	10h	20h
1.60V	534	357	251	149	109	87.3	75.5	65.0	51.8	42.8	22.7
1.65V	521	350	244	148	109	86.8	75.1	64.6	51.5	42.7	22.6
1.70V	502	339	236	147	108	86.2	74.6	64.2	51.1	42.5	22.5
1.75V	485	331	229	145	107	85.6	74.1	63.7	50.8	42.3	22.4
1.80V	459	319	221	141	104	83.0	71.8	61.8	49.3	42.0	22.3

Note: The above characteristics data can be obtained within three charge or discharge cycles.

NPD2-200Ah 2V200Ah

Discharge characteristics(25°C)

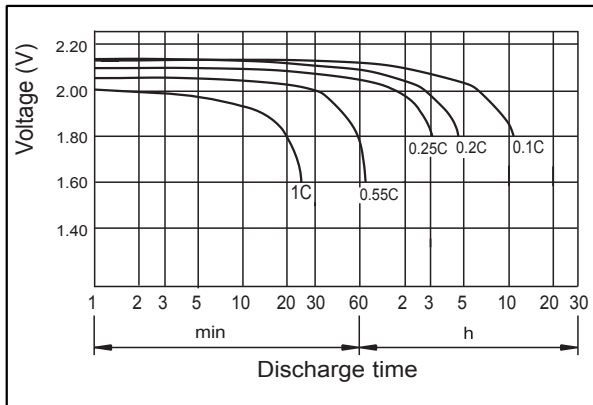

Charging characteristics

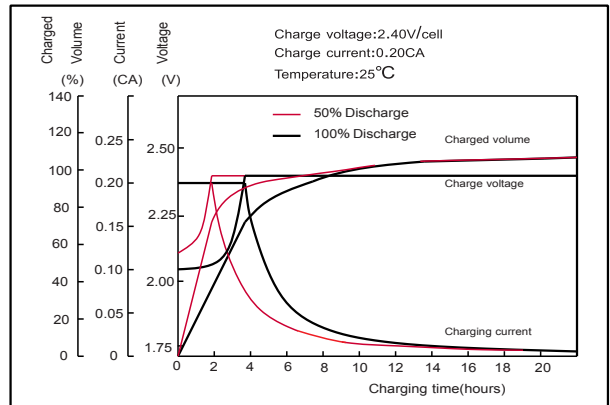

Effect of Temperature on Capacity

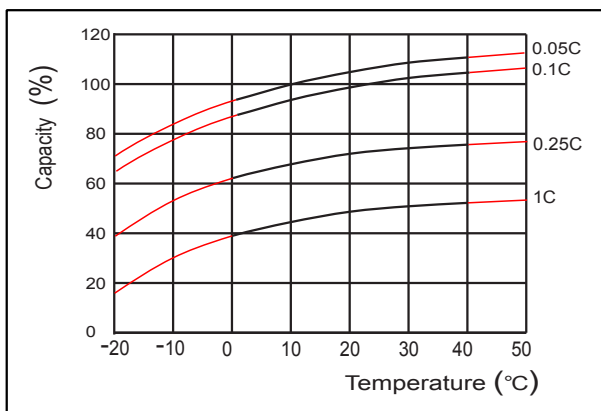

Self-discharge characteristics

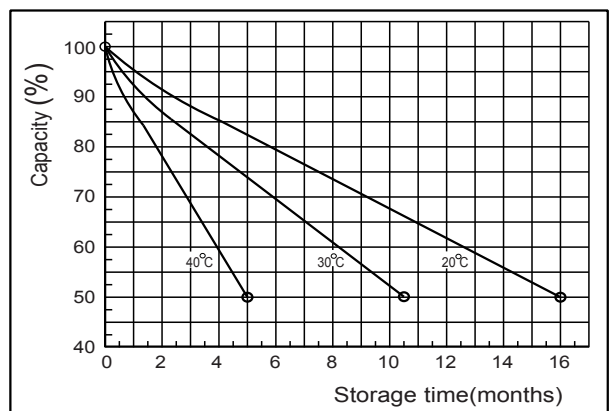

Temperature effects on float life

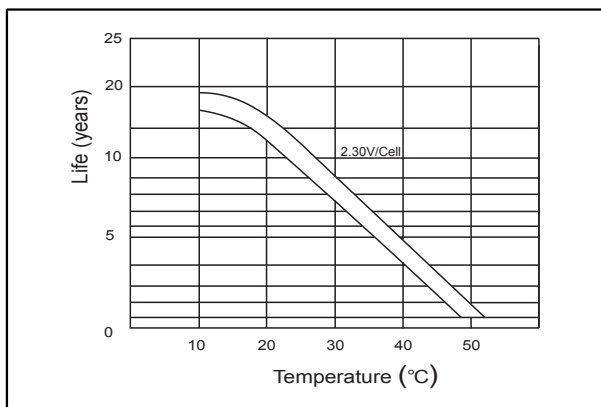

Cycle service life in relation to depth of discharge

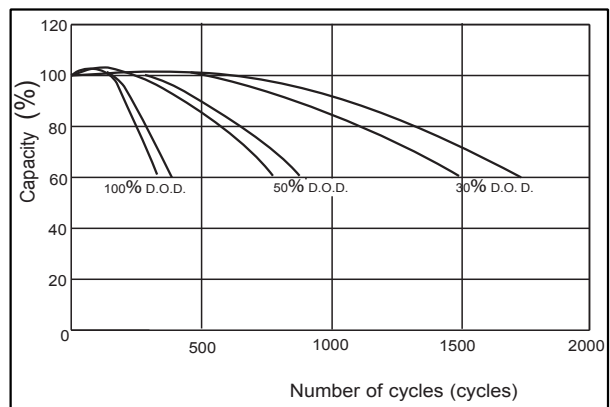

The relationship for OCV and Capacity (25°C)

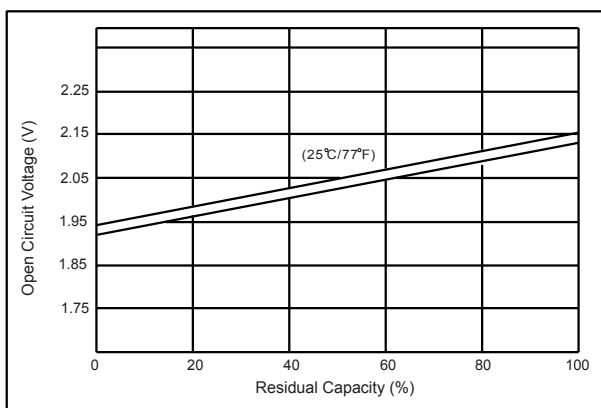

The relationship for Charging voltage and Temperature

