

NPG6-100Ah 6V100Ah

● **Specifications**

Nominal Voltage		6V
Rated capacity (10 hour rate)		100Ah
Dimensions	Length	194±2mm(7.64inch)
	Width	170±2mm(6.691inch)
	Height	205±2mm(8.07inch)
	Total Height	210±2mm(8.27inch)
Approx. Weight		16kg(35.3lbs)±3%

● **Outer dimensions (mm)**

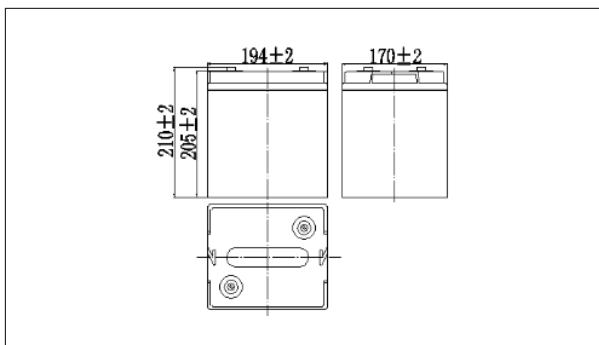

● **Terminal Type (mm)**

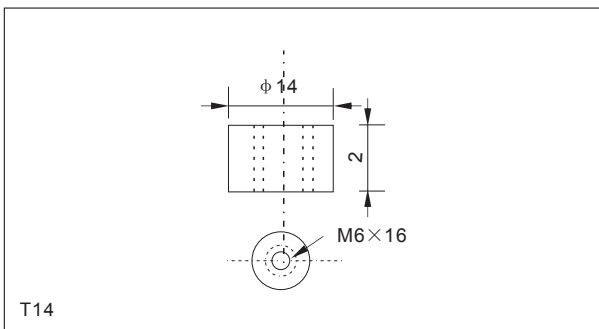

● **Characteristics**

Capacity (25°C)	10HR(5.40V)	100Ah
	3HR(5.40V)	75Ah
	1HR(5.25V)	55Ah
Terminal type		T14
Internal resistance (Fully charged,25°C)		Approx.3m Ω
Capacity affected by temperature (10HR)	40°C	102%
	25°C	100%
	0°C	85%
	-15°C	65%
Self-discharge (25°C)	3 months	Remaining Capacity:91%
	6 months	Remaining Capacity:82%
	12 months	Remaining Capacity:65%
Nominal operating temperature		25°C ±3°C(77°F ±5°F)
Operating temperature range	Discharge	-15°C~50°C(5°F~122°F)
	Charge	-10°C~50°C(14°F~122°F)
	Storage	-20°C~50°C(-4°F~122°F)
Float charging voltage(25°C)		6.75 to 6.90V Temperature compensation: -9mV/°C
Cyclic charging voltage(25°C)		7.20 to 7.35V Temperature compensation: -15mV/°C
Maximum charging current		20A
Maximum discharge current		800A(5 sec.)
Designed floating life(20°C)		12years

● **Construction**

Component	Positive plate	Negative plate	Container	Cover	Separator	Electrolyte	Safety valve	Terminal
Raw material	Lead dioxide	Lead	ABS	ABS	AGM	Gel	Rubber	Copper

● **Constant Current Discharge Characteristics Unit:A(25°C,77°F)**

F.V/Time	10min	15min	30min	60min	2h	3h	4h	5h	8h	10h	20h
4.80V	195	160	97.0	60.0	36.5	26.0	20.4	17.3	12.2	10.2	5.40
4.95V	189	156	95.1	59.1	36.3	25.9	20.3	17.2	12.2	10.2	5.38
5.10V	181	150	92.2	57.6	36.0	25.7	20.1	17.1	12.1	10.1	5.37
5.25V	174	145	89.9	55.8	35.5	25.5	20.0	17.0	12.0	10.1	5.34
5.40V	164	138	86.6	54.0	34.6	25.0	19.4	16.5	11.6	10.0	5.30

● **Constant Power Discharge Characteristics Unit:W(25°C,77°F)**

F.V/Time	10min	15min	30min	60min	2h	3h	4h	5h	8h	10h	20h
4.80V	1053	878	544	342	212	153	120	102	72.7	60.8	32.4
4.95V	1021	857	533	337	210	152	119	102	72.3	60.7	32.3
5.10V	979	826	517	328	208	151	118	101	71.8	60.5	32.2
5.25V	937	798	504	318	205	150	118	100	71.3	60.1	32.0
5.40V	885	755	486	308	200	147	114	97.5	69.1	59.7	31.8

Note: The above characteristics data can be obtained within three charge or discharge cycles.

NPG6-100Ah 6V100Ah

● Discharge characteristics(25°C)

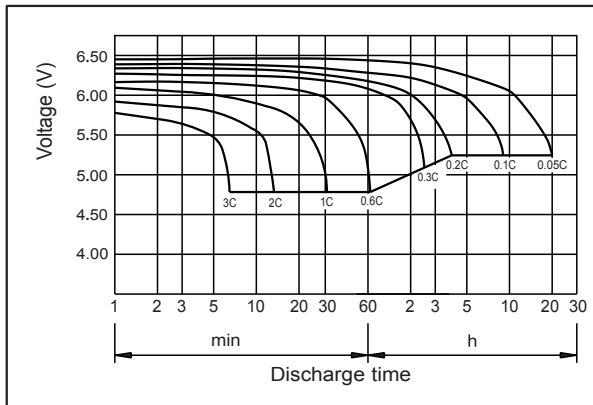

● Charging characteristics(25°C)

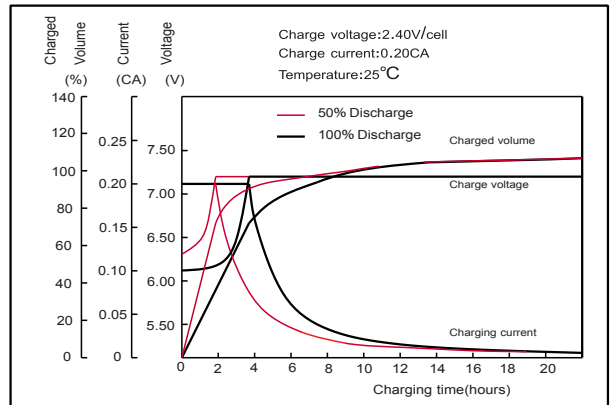

● Effect of temperature on capacity

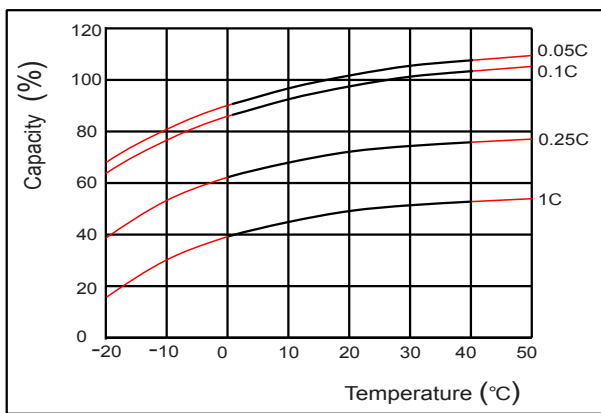

● Self-discharge characteristics

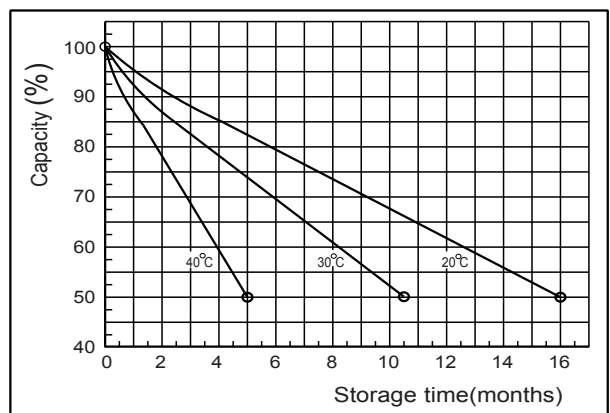

● Floating life on temperature

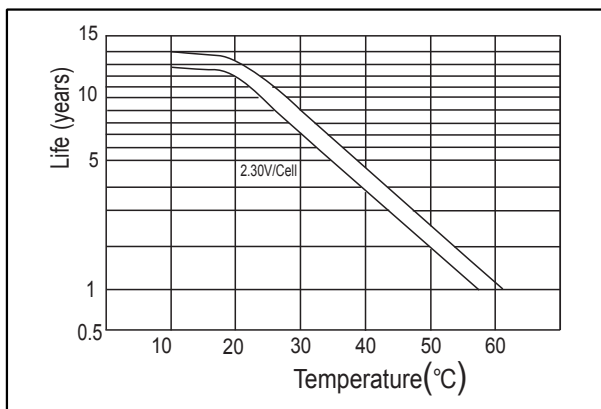

● Cycle life on D.O.D (25°C)

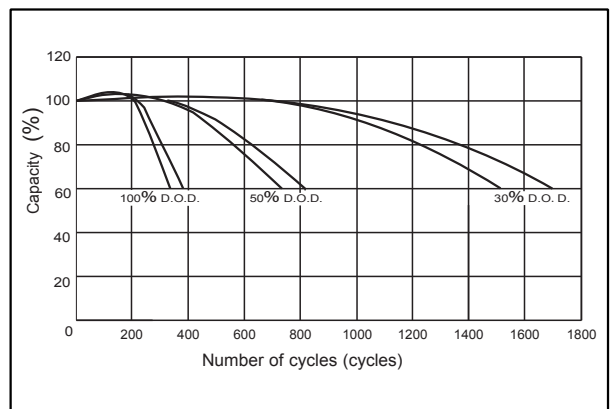

● The relationship for OCV and Capacity (25°C)

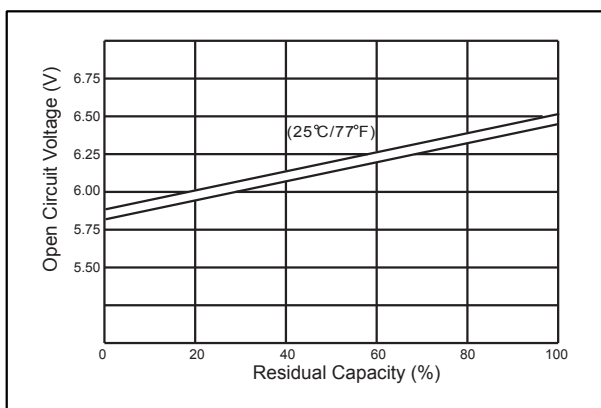

● The relationship for Charging voltage and Temperature

