

HR12280W (12V280 Watts/cell)

● Specifications

Nominal Voltage		12V
Number of cell		6 cells
Rated capacity(15min.rat)		280 Watts/cell
Dimensions	Length	260±2mm(10.24inch)
	Width	168±2mm(6.61inch)
	Height	211±2mm(8.31inch)
	Total Height	215±2mm(8.46inch)
Approx. Weight		25.3kg(55.8lbs)±3%



● Outer dimensions (mm)

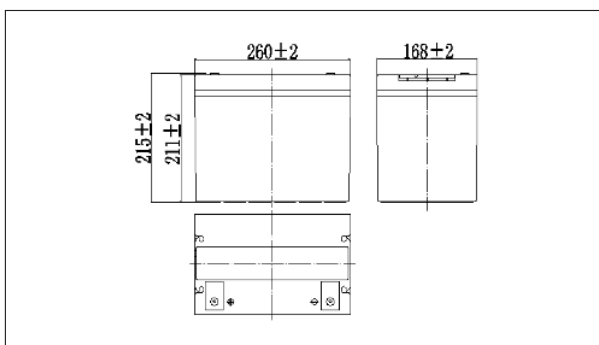

● Terminal Type (mm)

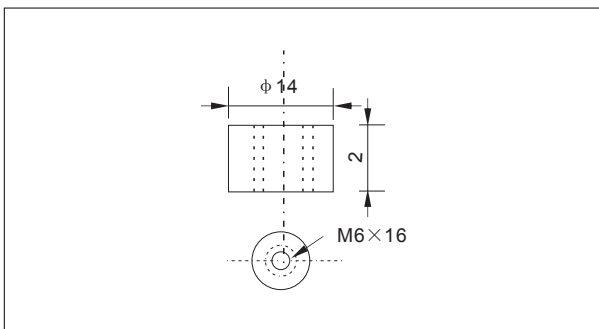

● Construction

Component	Positive plate	Negative plate	Container	Cover	Separator	Electrolyte	Safety valve	Terminal
Raw material	Leaddioxide	Lead	ABS	ABS	AGM	Sulfuric acid	Rubber	Copper

● Constant Current Discharge Characteristics Unit:A(25°C,77°F)

F.V/Time	10min	15min	20min	30min	45min	60min	2h	3h	4h	5h	6h
1.60V/cell	183	150	120	84.9	63.3	51.6	27.4	19.7	15.8	13.8	11.8
1.67V/cell	175	145	115	82.2	61.2	50.3	27.2	19.5	15.7	13.6	11.7
1.70V/cell	170	141	113	80.7	60.1	49.6	27.0	19.4	15.6	13.6	11.6
1.75V/cell	163	136	109	78.7	58.7	48.6	26.6	19.3	15.5	13.5	11.6
1.80V/cell	154	129	103	75.8	56.5	47.1	25.9	18.7	15.1	13.1	11.2

● Constant Power Discharge Characteristics Unit:W(25°C,77°F)

F.V/Time	10min	15min	20min	30min	45min	60min	2h	3h	4h	5h	6h
1.60V/cell	344	289	231	164	122	99.6	53.4	38.7	31.2	27.3	23.3
1.67V/cell	329	281	222	159	118	97.1	53.0	38.4	30.9	27.0	23.1
1.70V/cell	320	272	217	159	116	95.6	52.7	38.2	30.8	26.9	23.0
1.75V/cell	306	263	210	152	113	93.7	51.9	38.0	30.6	26.7	22.9
1.80V/cell	289	249	199	146	109	90.9	50.5	36.8	29.7	25.9	22.2

Note: The above characteristics data can be obtained within three charge or discharge cycles.

● Characteristics

Capacity(10HR,25°C)	70Ah	
Capacity(15min.rate,25°C)	280 Watts/cell	
Terminal type	T14	
Internal resistance (Fully charged,25°C)	Approx.5m Ω	
Capacity affected by temperature (10HR)	40°C	102%
	25°C	100%
	0°C	85%
	-15°C	65%
Self-discharge (25°C)	3month	Remaining Capacity:91%
	6month	Remaining Capacity:82%
	12month	Remaining Capacity:65%
Nominal operating temperature	25°C ±3°C(77°F ±5°F)	
Operating temperature range	Discharge	-15°C~50°C(5°F~122°F)
	Charge	-10°C~50°C(14°F~122°F)
	Storage	-20°C~50°C(-4°F~122°F)
Float charging voltage(25°C)	13.50 to 13.80V Temperature compensation: -18mV/°C	
Cyclic charging voltage(25°C)	14.50 to 15.00V Temperature compensation: -30mV/°C	
Maximum charging current	21A	
Terminal material	Copper	
Maximum discharge current	700A(5 sec.)	
Designed floating life(20°C)	10years	

HR12280W (12V280 Watts/cell)

● Discharge characteristics(25°C)

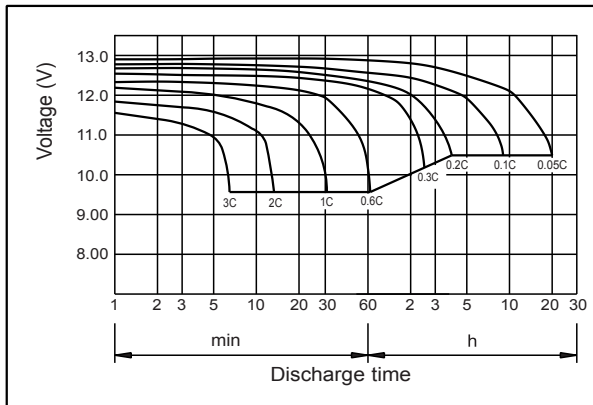

● Charging characteristics (25°C)

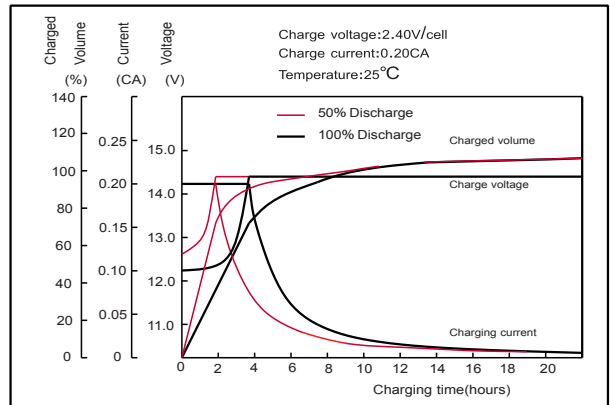

● Effect of Temperature on Capacity

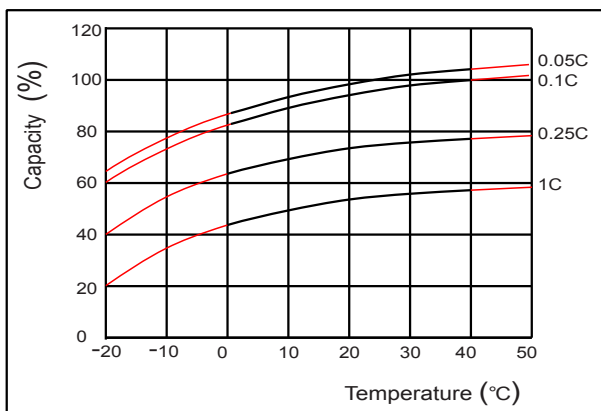

● Self-discharge characteristics



● Floating Life on Temperature

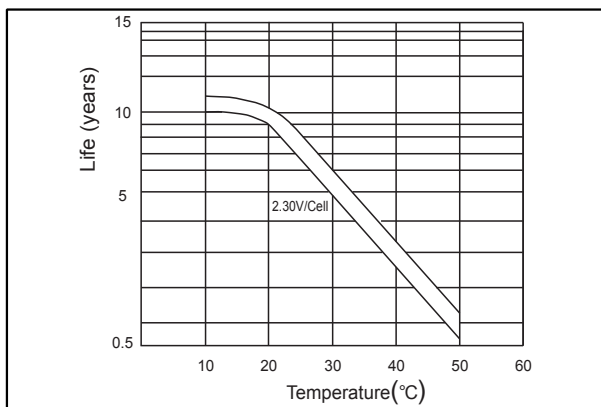

● Cycle service Life on D.O.D (25°C)

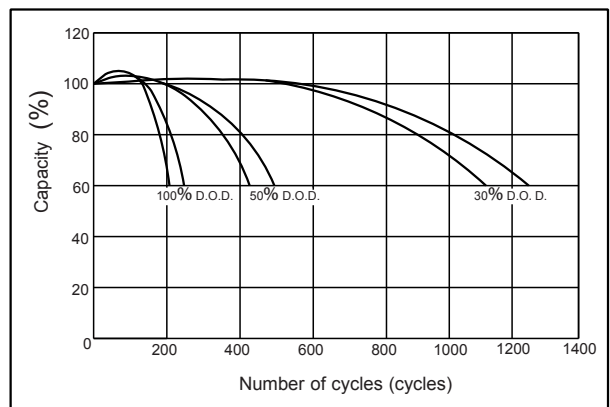

● The relationship for OCV and Capacity (25°C)

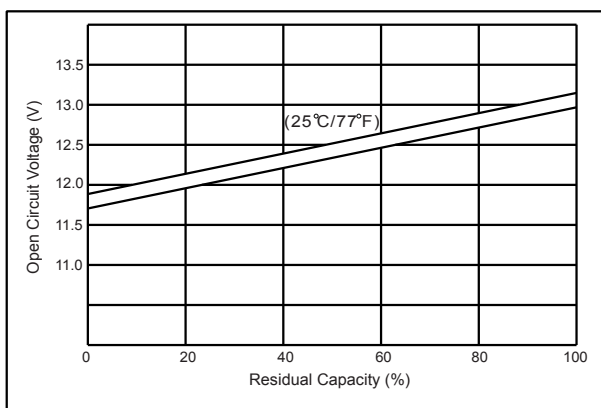

● The relationship for Charging voltage and Temperature

