

## HR12330W (12V330 Watts/cell)

### ● Specifications

Nominal Voltage	12V	
Number of cell	6 cells	
Rated capacity(15min.rat)	330 Watts/cell	
Dimensions	Length	306±2mm(12.05inch)
	Width	169±2mm(6.65inch)
	Height	211±2mm(8.31inch)
	Total Height	215±2mm(8.46inch)
Approx. Weight	28.5kg(62.8lbs)±3%	



### ● Outer dimensions (mm)

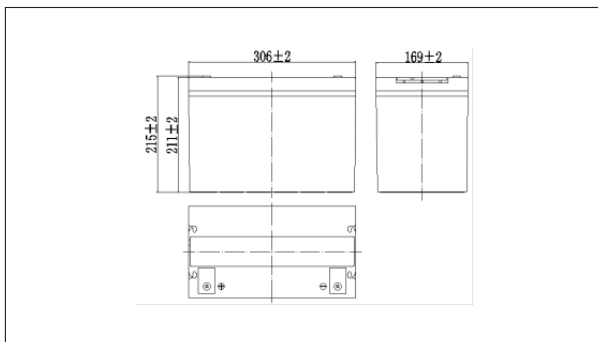

### ● Terminal Type (mm)

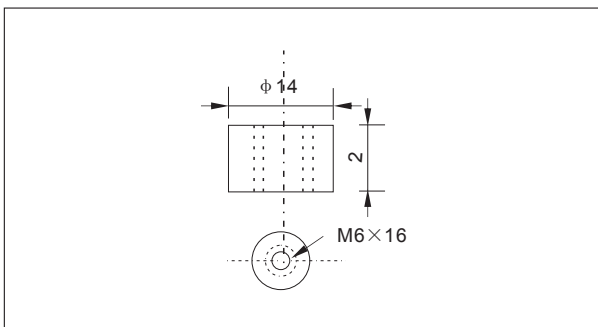

### ● Construction

Component	Positive plate	Negative plate	Container	Cover	Separator	Electrolyte	Safety valve	Terminal
Raw material	Leaddioxide	Lead	ABS	ABS	AGM	Sulfuric acid	Rubber	Copper

### ● Constant Current Discharge Characteristics Unit:A(25°C,77°F)

F.V/Time	10min	15min	20min	30min	45min	60min	2h	3h	4h	5h	6h
1.60V/cell	215	176	141	99.8	74.4	60.7	34.7	24.9	20.1	17.4	14.9
1.67V/cell	206	171	135	96.6	72.0	59.2	34.4	24.7	19.9	17.3	14.8
1.70V/cell	200	166	132	94.8	70.6	58.2	34.2	24.6	19.8	17.2	14.7
1.75V/cell	192	160	128	92.5	68.9	57.1	33.7	24.4	19.7	17.1	14.6
1.80V/cell	181	151	121	89.1	66.4	55.3	32.8	23.7	19.1	16.6	14.2

### ● Constant Power Discharge Characteristics Unit:W(25°C,77°F)

F.V/Time	10min	15min	20min	30min	45min	60min	2h	3h	4h	5h	6h
1.60V/cell	405	340	272	193	144	117	67.7	49.1	39.5	34.5	29.5
1.67V/cell	386	330	261	186	139	114	67.1	48.6	39.2	34.2	29.3
1.70V/cell	376	320	256	183	136	112	66.7	48.4	39.0	34.1	29.2
1.75V/cell	360	309	247	179	133	110	65.7	48.1	38.7	33.9	29.0
1.80V/cell	340	292	234	172	128	107	64.0	46.7	37.6	32.8	28.1

Note: The above characteristics data can be obtained within three charge or discharge cycles.

### ● Characteristics

Capacity(10HR,25°C)	90Ah	
Capacity(15min.rate,25°C)	330 Watts/cell	
Terminal type	T14	
Internal resistance (Fully charged,25°C)	Approx.5m Ω	
Capacity affected by temperature (10HR)	40°C	102%
	25°C	100%
	0°C	85%
	-15°C	65%
Self-discharge (25°C)	3month	Remaining Capacity:91%
	6month	Remaining Capacity:82%
	12month	Remaining Capacity:65%
Nominal operating temperature	25°C ±3°C(77°F ±5°F)	
Operating temperature range	Discharge	-15°C~50°C(5°F~122°F)
	Charge	-10°C~50°C(14°F~122°F)
	Storage	-20°C~50°C(-4°F~122°F)
Float charging voltage(25°C)	13.50 to 13.80V Temperature compensation: -18mV/°C	
Cyclic charging voltage(25°C)	14.50 to 15.00V Temperature compensation: -30mV/°C	
Maximum charging current	27A	
Terminal material	Copper	
Maximum discharge current	800A(5 sec.)	
Designed floating life(20°C)	10years	

## HR12330W (12V330 Watts/cell)

### ● Discharge characteristics(25°C)

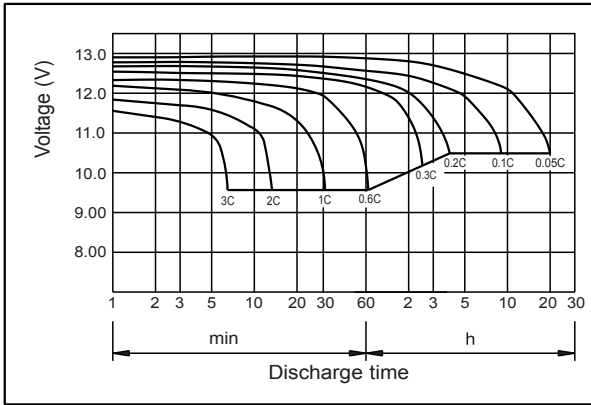

### ● Charging characteristics (25°C)

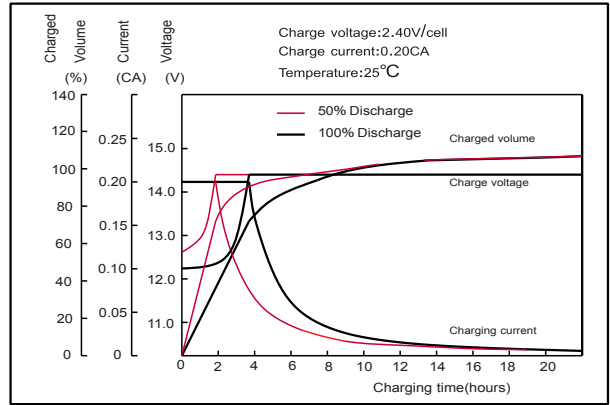

### ● Effect of Temperature on Capacity

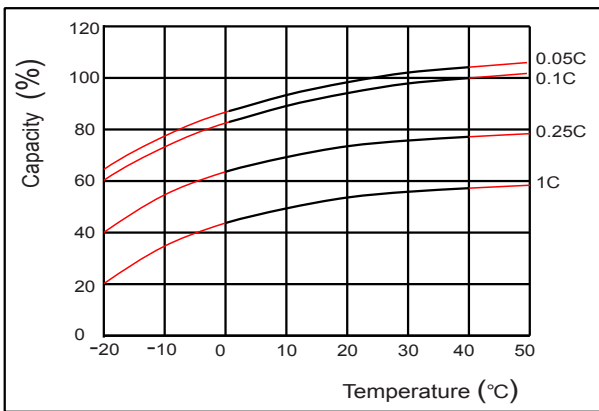

### ● Self-discharge characteristics

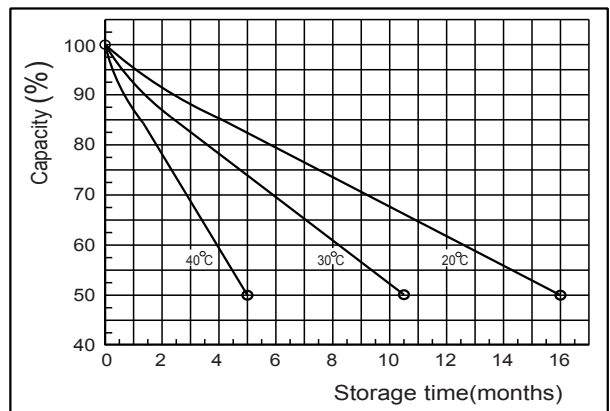

### ● Floating Life on Temperature

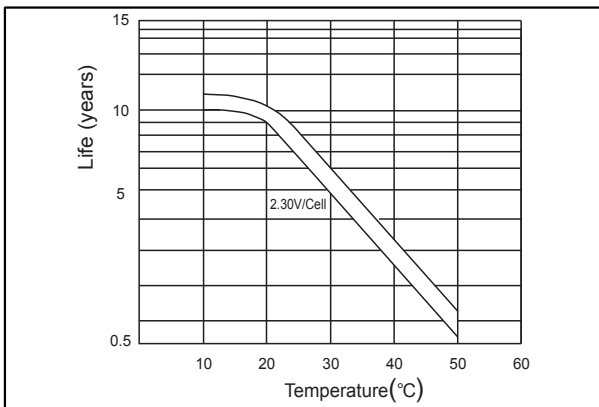

### ● Cycle service Life on D.O.D (25°C)

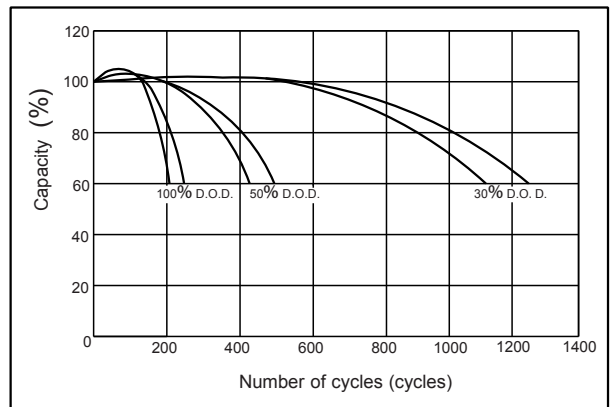

### ● The relationship for OCV and Capacity (25°C)

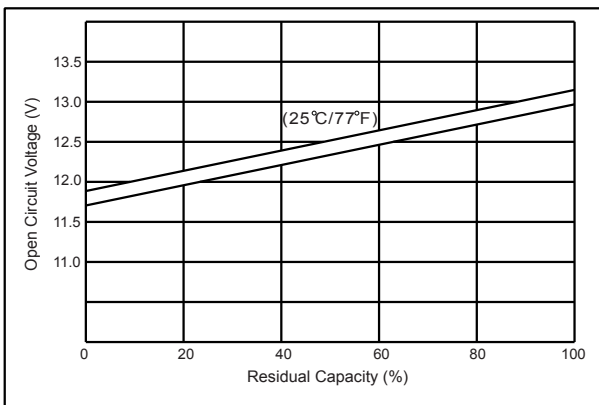

### ● The relationship for Charging voltage and Temperature

